

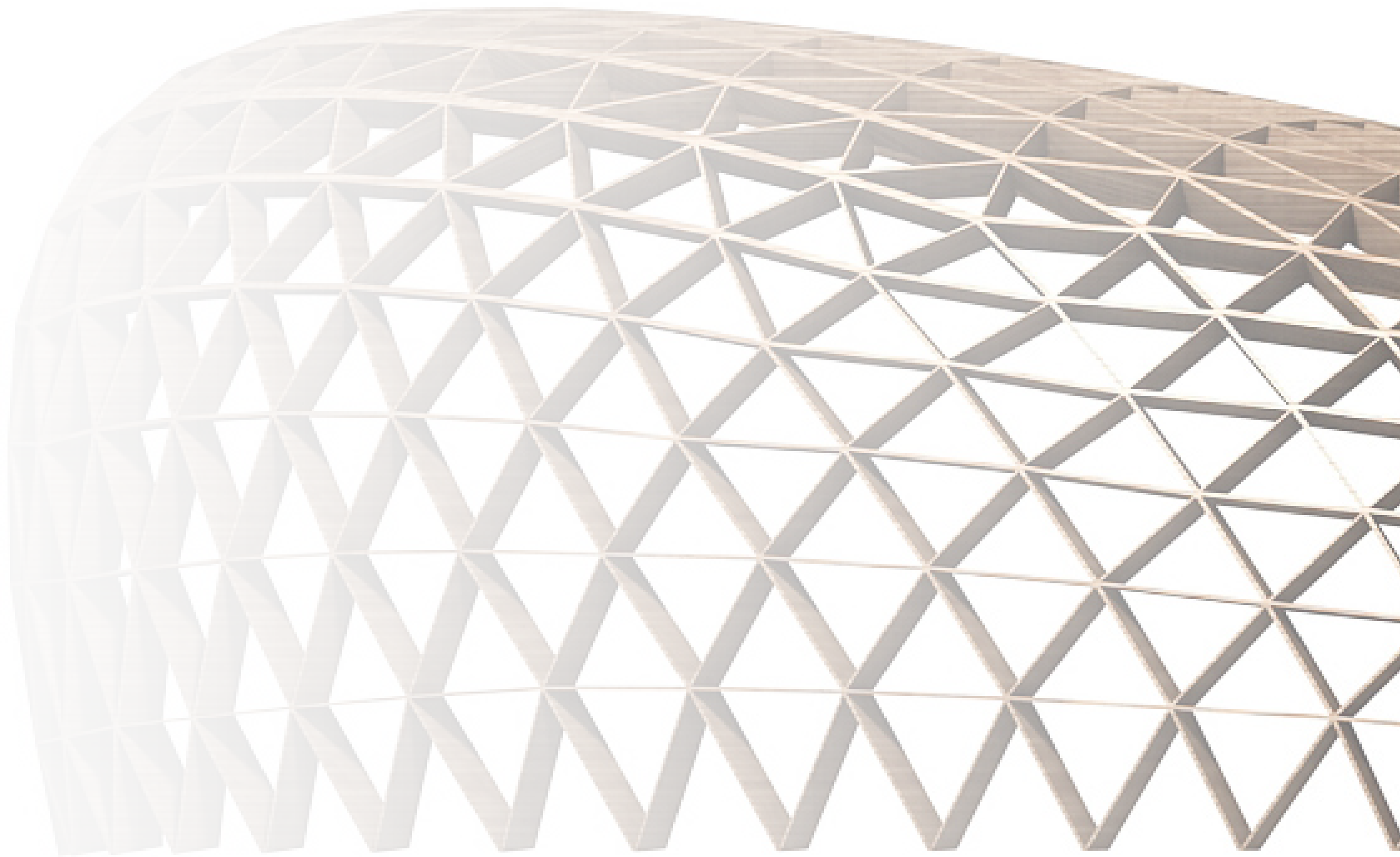

FREE FORM BUILDINGS

“Consider the beauty of a tree in its bareness, not its leaves.”
the mother of Samuel Menashe

INTRODUCTION	1.1 THE AIM OF THIS BOOKLET	5	
CONCEPT AND PATENT	2.1 CONCEPT 2.2 PATENT ABSTRACT	6	
CONSTRUCTION SYSTEM	3.1 MOCK-UP 3.2 ARC	8	
SAMPLE PROJECTS	4.1 DESIGN PROCESS 4.2 FREE FORM BUILDINGS 01 - GRAVEL HOUSE 4.3 FREE FORM BUILDINGS 03 - FAMILY HOUSE 4.4 FREE FORM BUILDINGS 04 - MULTIFUNCTIONAL HALL	12	
ANALYSIS AND CONCLUSIONS	5.1 GEOMETRY 5.2 ENERGETICS 5.3 STATICS 5.4 ENVIRONMENTAL 5.5 APPLICABILITY 5.6 PERFORMANCE EVALUATION	24	
AUTHORS AND CONTRIBUTORS	7.1 PERSONAL PRESENTATION 7.2 CONSULTANT DESIGNERS 7.3 DEVELOPER	36	



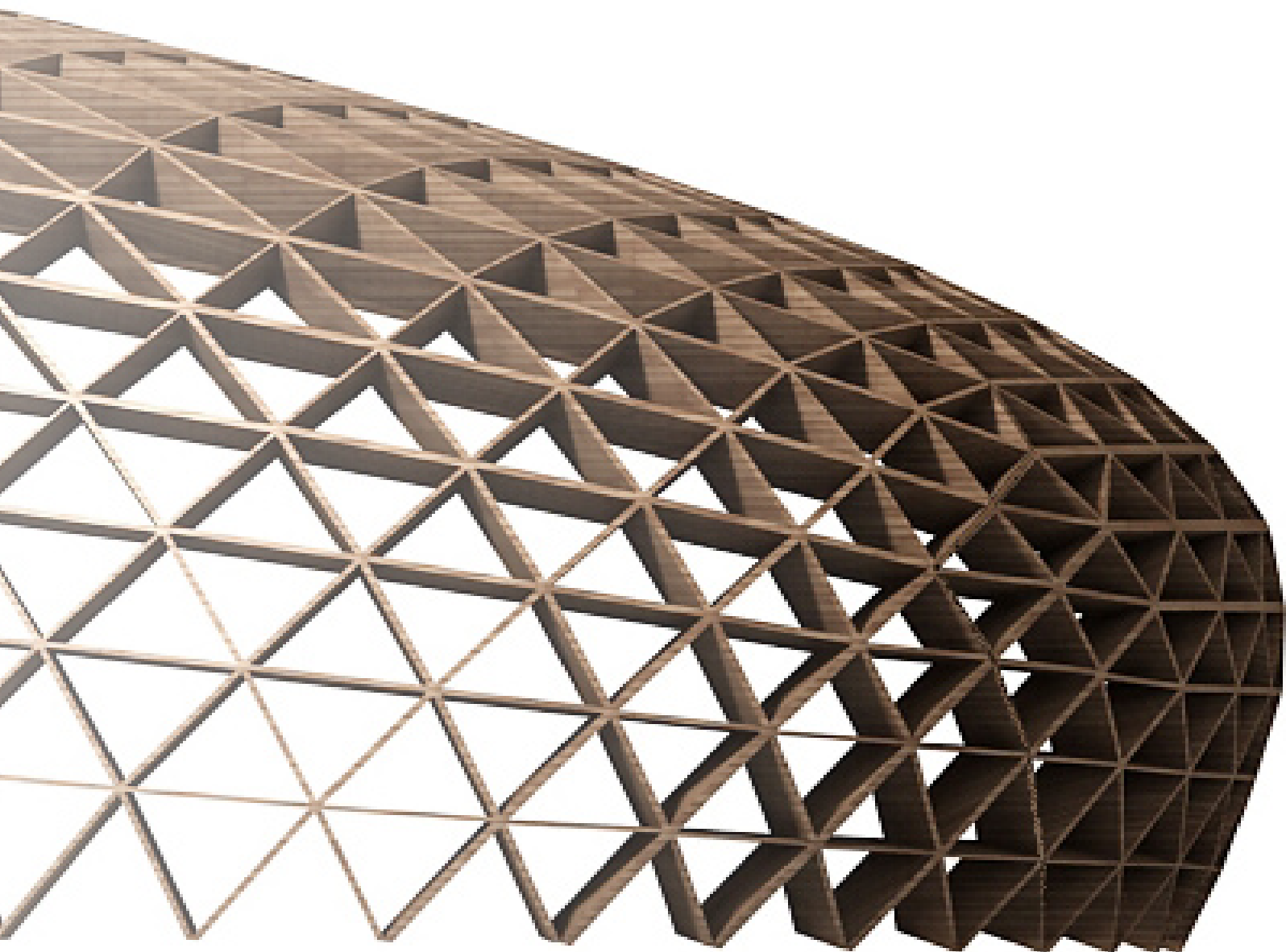

1.1 THE AIM OF THIS BOOKLET

Dear Reader, this booklet contains a description of a new construction method, the concept of which we developed and patented in 2009. To introduce it to the construction market, we plan to construct two exhibitory buildings and spread a communication material based on the documentation of them.

The aim of our construction system is to assure energy efficiency and environmental soundness for the entire life-cycle of the building.

To achieve this, we applied up-to-date materials and technologies of the design and construction industry, creating a **new building concept**.

As a result we have a new construction method, by which our building answers appropriately to the topical demands: the adaptation of contemporary technologies and materials, as well as increased consideration of the natural, built and cultural environment.

We invite You to participate in our project with Your products and technology. We would like as well to offer You our services to design and to build a structure based on the presented material.

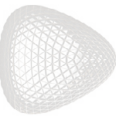
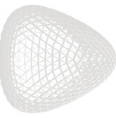
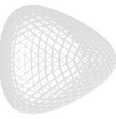
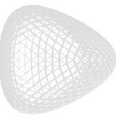
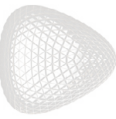
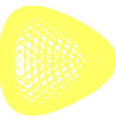

2.1 CONCEPT

Our research started by analysing the current answers of the construction industry and market to the new energetic demands and green primaries.

- Technical aspects:

In recent years, one of the primary necessities of an energy strategy became the reduction of the heat exchange between the building and the external medium.

The primal answer to this demand was to increase the thickness of the usual insulation panels applied on the external walls. Later innovative solutions appeared in materials and mechanical technologies as well.

Unfortunately the costs of these developments are still high, the process of changing the latest decades' technology is still difficult.

Apart from economical aspects, the coordination between the applied technologies in different fields (as architectural design concept, construction technology or mechanical systems) is not done uniformly or is inconsistent.

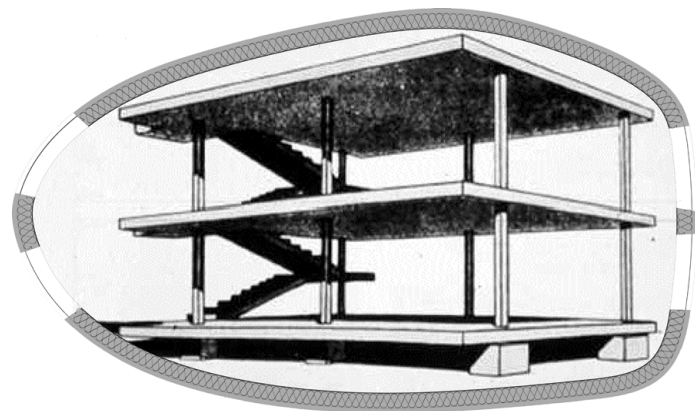

- Architectural principles:

In modern design – compared to the number of the newly built premises – we found only a few examples of space formation concepts based on energetic aspects.

The base of the architectural shape of the building is still the application of models that are aesthetically formalist or economically profitable on a short term.

The modulation of the architectural space is still generated from the model formed by Le Corbusier, the exception being the **3D design** applied only by a relatively small number of some leading design offices like Coop Himmelb(l)au, Herzog & de Meuron or a very few others.

The application of the regulations and standards is not enough any more to build adequately to current demands concerning energy efficiency. According to these new demands, we need to modify the existing systems by the overall coordination of the main fields that determine a building: architecture, **structure**, mechanical and electrical systems.

The structure's cohesion with the other fields of architectural engineering, for example the consideration of thermal bridges, the thermostatic properties of the materials, the position and size of insulation or glass surfaces needs to be **reconsidered**. Innovations in the field of mechanical systems make more efficient and energetically sensitive buildings. As architects we considered all these demands from the consultant designers in the development of our concept. Our aim is

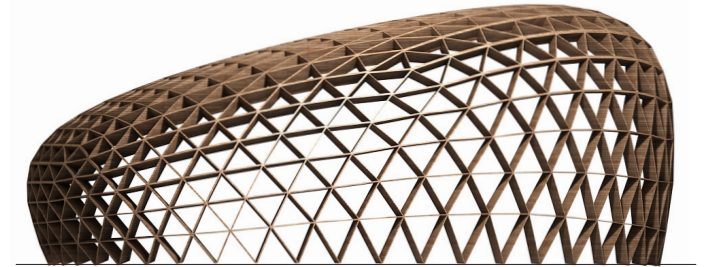

to design new buildings based on the basic criteria of reducing the amount of energy necessary for the construction and during the use of the edifices; to assign more freedom to form spaces and building shapes while increasing consideration for the environment, and to facilitate the application of new technologies. All this in an economically favourable way, using simple technologies and available materials.

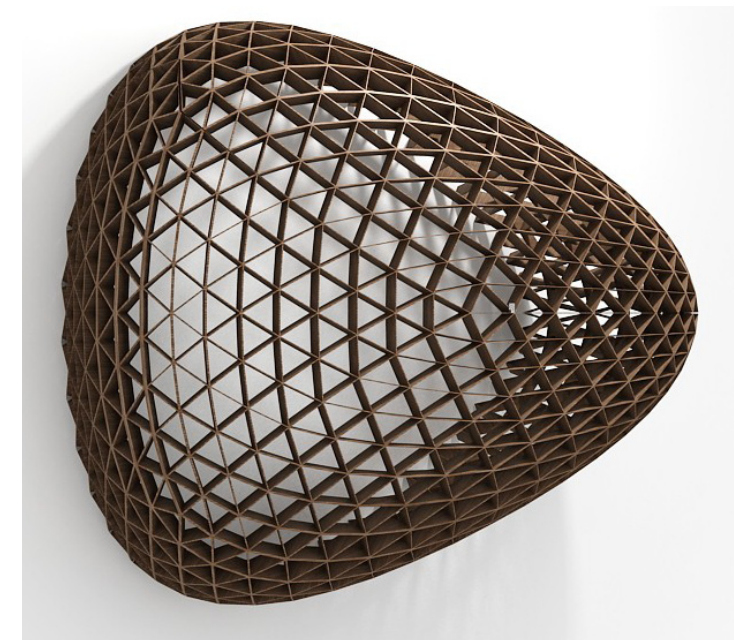

The presented innovation was developed during the design process of the thermic shell for a family house based on passive-house technology; in the following we present our proposal to achieve these goals by a novel professional statement.

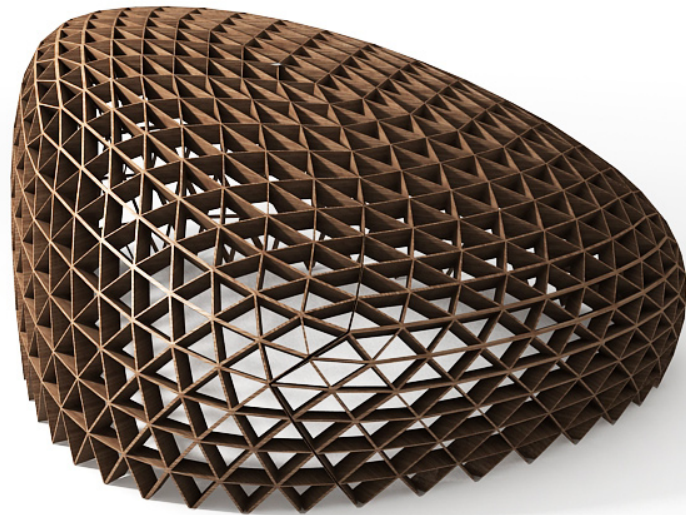

2.2 PATENT ABSTRACT

Polyhedral surfaced, celled, space dividing structure.

The components are: 1.- shell-sheets, 2.- connection-sheets and 3.- fixing-elements, made of oriented standard board panels, timber panels, medium-density fibreboard panels, slate panels, timber boards, steel profiles, metal sheets or the mixture of these materials, fixed between themselves with screws, bolts, pegs, tacks, adhesives, welding or the combination of these.

The regular or irregular polyhedral surface of the structure is composed of polygonal elements, assigning concave or convex curved character to the structure.

The number of the shells formed by the shell-sheets (1) is variable.

In the interior of the structure, the shell-sheets (1) and the connection-sheets (2) form cells, which can be filled with materials such as concrete, thermal insulation, or the mixture of them.

The adaptation of the structure in the building can be internal or external, covered by the appropriate cladding materials.

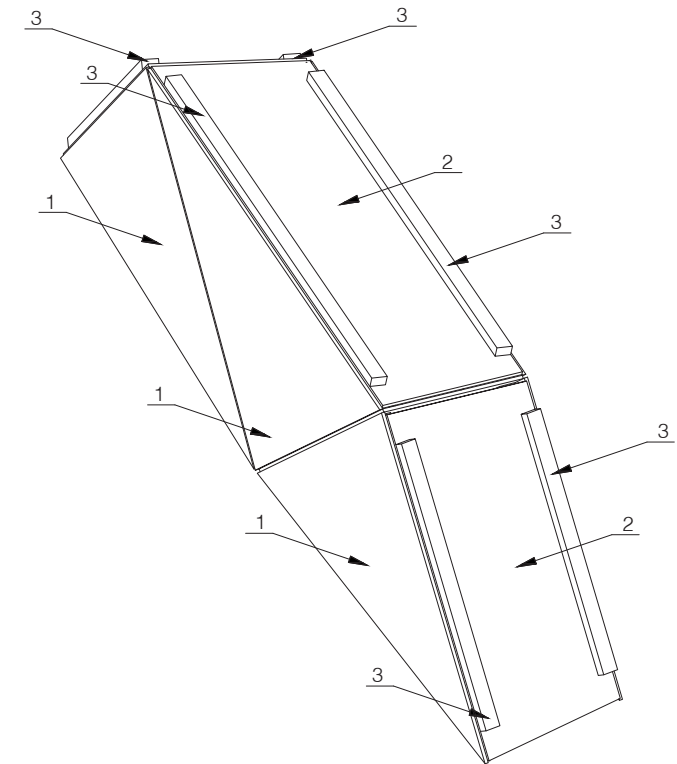

Typical drawing: example of a two-shelled, polyhedral surfaced, celled, space dividing structure – axonometric view.



3.1 MOCK-UP

For one of the designed sample house -by which we are presenting the building system- we built a detail of the external wall structure, at the scale of 1:1. During its construction we tested the technology of the method by measuring the duration of the procedure, the possibilities of cutting, positioning, fixing, and potential arrangements of coverings.

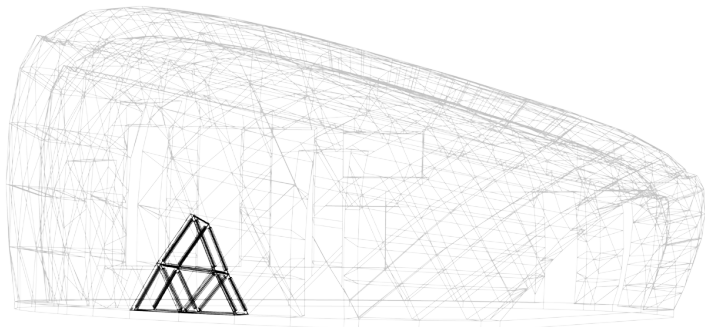

1 - Drawing, cutting, preparation and transport of the components, which are:

- triangles: the composers of the inner and outer shell

- parallelograms: the connection between the shells

- slats: through which the panels are fixed

2 - Positioning and fixing of the starting slats on the foundation slab. The connections can be made by using screws, bolts, pegs, tacks, adhesives and the combination of these.

3 - Positioning and fixing of the starting triangles to the slats.

4 - Positioning and fixing of the parallelograms to the triangles, by the previously applied slats.

In this way we form closed, internal cells.

5 - Connecting the cells by more shell forming triangles, then placing new internal connection parallelograms. These are the basic steps of the method to build the structural shell.

6 - Positioning and fixing of the structure for the covering materials: slats on the connection edges of the external planes.

7 - Filling of the cells with cellulose insulation. The procedure can be done from the internal or the external shell-sheet, after which the apertures are closed. The covering of the structure, in our case, was made of wooden boarding on the external plane and of gypsum board panels on the internal surface.

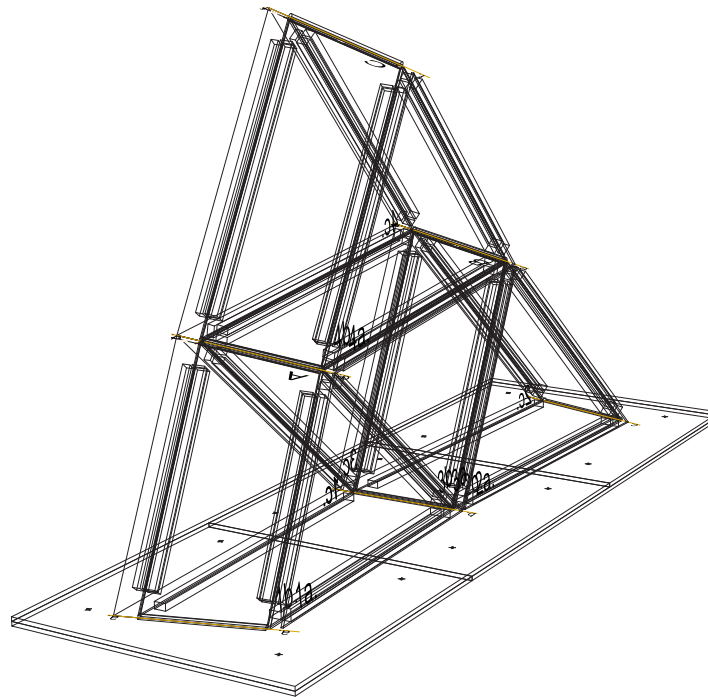

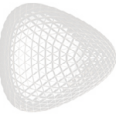
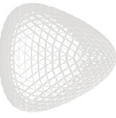
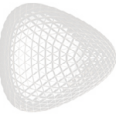
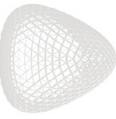
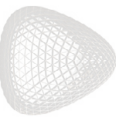

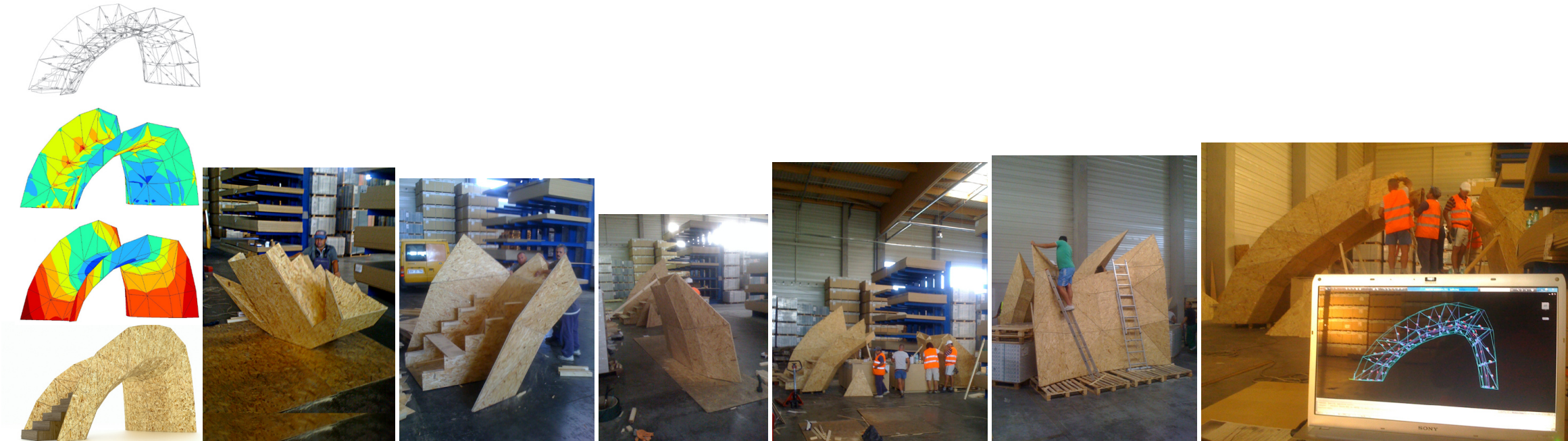

3.2 ARC

General description

When we contacted the firm Kronospan -producer of wood based construction materials- to participate in the construction in our exhibitory houses – to which the company readily agreed –, Kronospan also suggested that we take part in the „In House Fair” exhibition by building an arch at the entrance. We built a platform on the topmost point of the arch and a stairway so that visitors could go up; this allowed us to demonstrate at the same time the load-bearing capacity of the structure.

Geometrically, the structure consists of two doubly curved arcs that have joint edges, but have a distance of around 40 cm in the middle to hold the connecting panels.

General sizes of the arc: length 620 cm, width 350 cm, height 361 cm, while the height of the passage is 215 cm.

The only composing materials and elements were 10 mm thick OSB-3 panels, pine slats of 48/48 mm and fixing bolts.

After cutting out the 330 pieces with a CNC machine, the structure was mounted within five days by a team of five people and after the exhibition the structure was dismantled.

During the exhibition the structure was loaded (apart from its dead load) by the visitors climbing up on it. This vertical load was, due to the structure’s geometry, transferred through the component panels’

plane to the floor acting as foundation. Thanks to the **excellent load-bearing capacity** of the OSB panels, the structure made of only 10 mm thick panels could bear more than seven people’s weight.



Structural dimensioning

The structure can be dimensioned with software using finite element method. The OSB panels were modelled as two-dimensional surfaces. The software calculates the dead load automatically, while as live loads the weight of approximately seven people was added.

The software calculates the structure with high accuracy, apart from small displacements in the nodes – this phenomenon is similar to those experienced in the construction of trusses.

Counting with a dead load of 500 kg, a live load of 600 kg and with horizontal loads of 100-100 kg on each side, the overall vertical displacement of the structure is 4,0 mm. This calculation proves that the

proposed thickness of 10 mm of the OSB boards is applicable, and determines the design value of stresses on nodes.

In order to minimise displacements in nodes, we applied bolts of small diameter (4/50 mm) every 100-120 mm, and oversized the nodes. The load-bearing capacity of the nodes can be augmented by using more bolts.

If, during the construction, gaps of more than 5 mm appear between the OSB panels and the fastening slats, adhesive polyurethane foam has to be injected.

In the dimensioning process we ignored the load-distributing effect of the two beams supporting the

stairway.

Conclusion: the structure is appropriate to bear a vertical load of 600 kg.





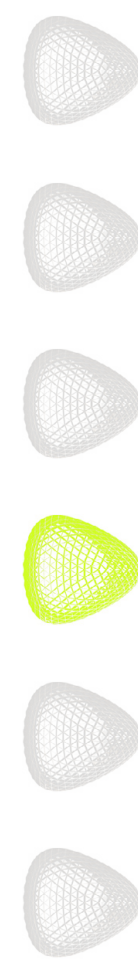
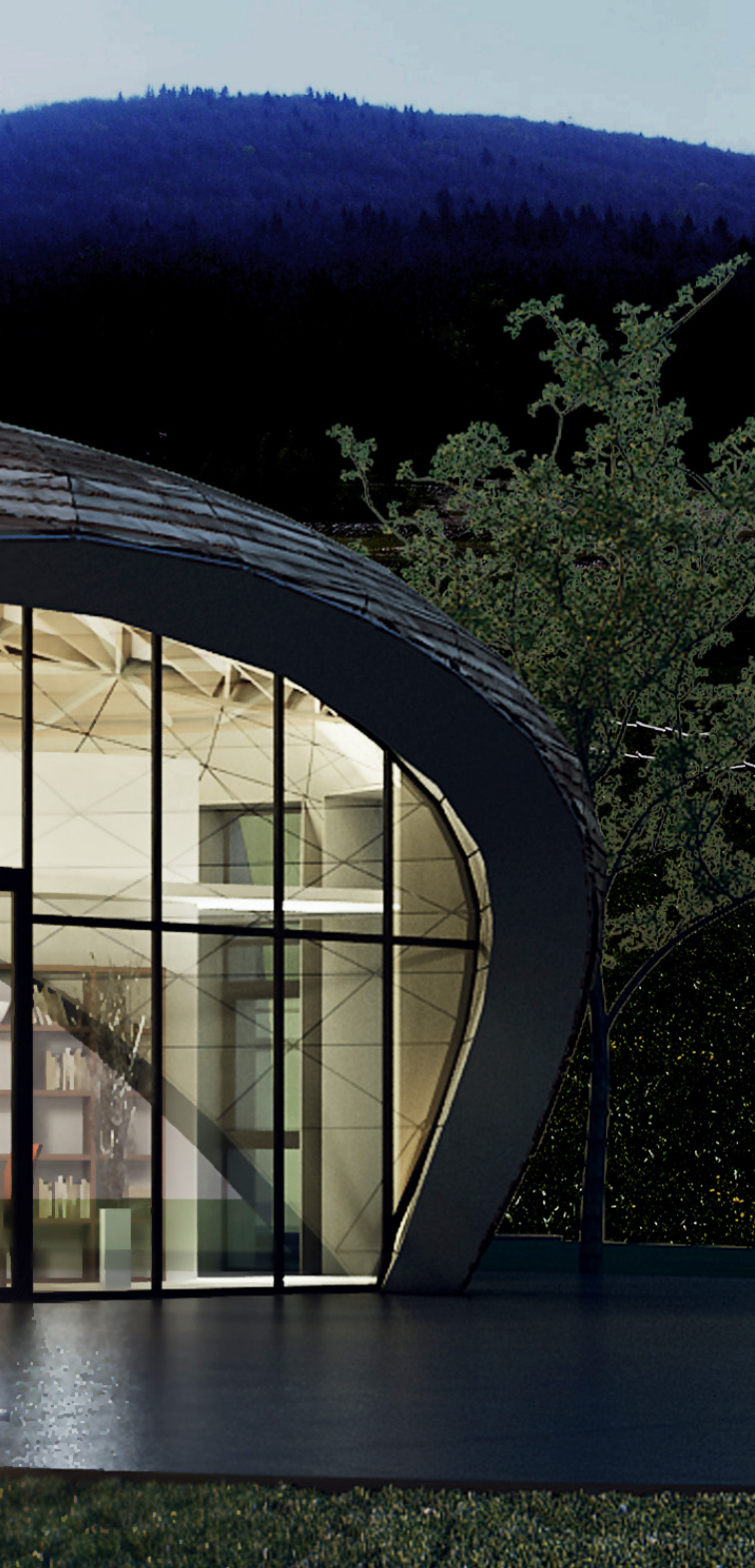

4.1 DESIGN PROCESS

Let us separate – in theory – the shell of a building from its inner space: with our construction system we suggest the **revision of the shell**. At the beginning of the design process – in accordance with the expectations – first the inner spaces, their dimensions, locations and relations are defined, hence creating the „inside” of the building. Then we define the shell, designing it according to the expectations regarding form, function, structure and isolation. After positioning the openings for passage and illumination and coating materials can be designed.

The definition of the shell is aided by a relevant software, which, in this phase of the design process,

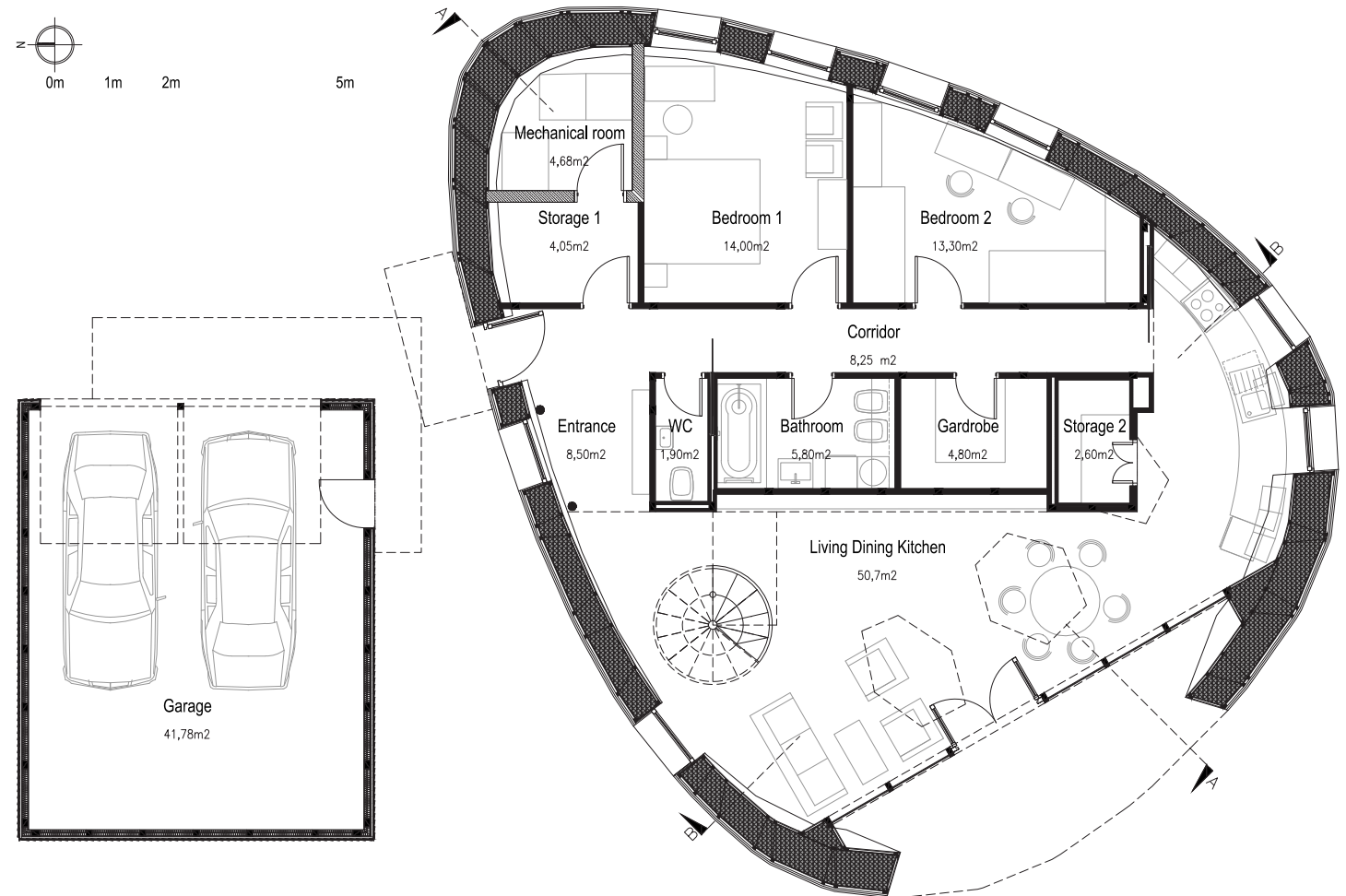
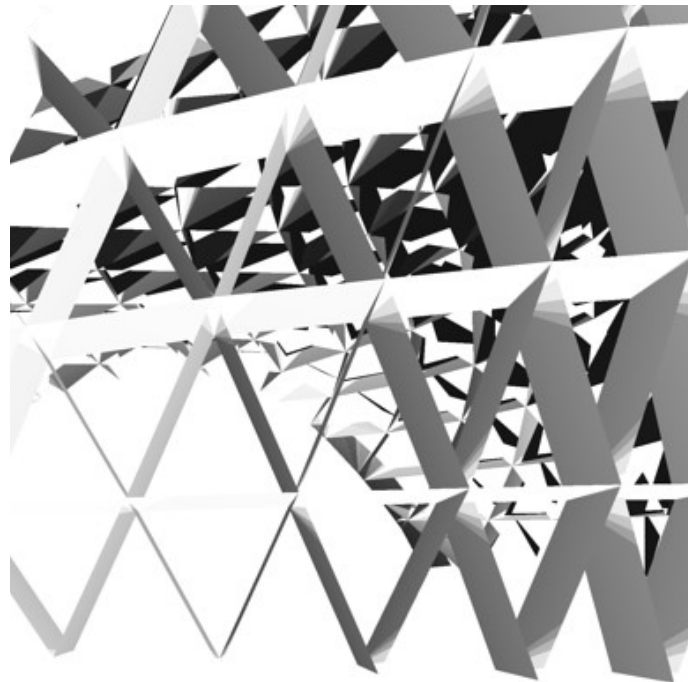

helps not only in graphic documentation, but also gives the opportunity to construct – virtually – the whole building before the actual real-life construction begins.

This 3D model of the building shell can be freely **transformed, stretched, distorted, thinned or thickened** in any direction, and simulated with different

coating materials. It helps control the design process by two-dimensional projections, renderings and 3D animations. It is based on this model that elements of the structure are dimensioned, cut and mounted on the construction site.

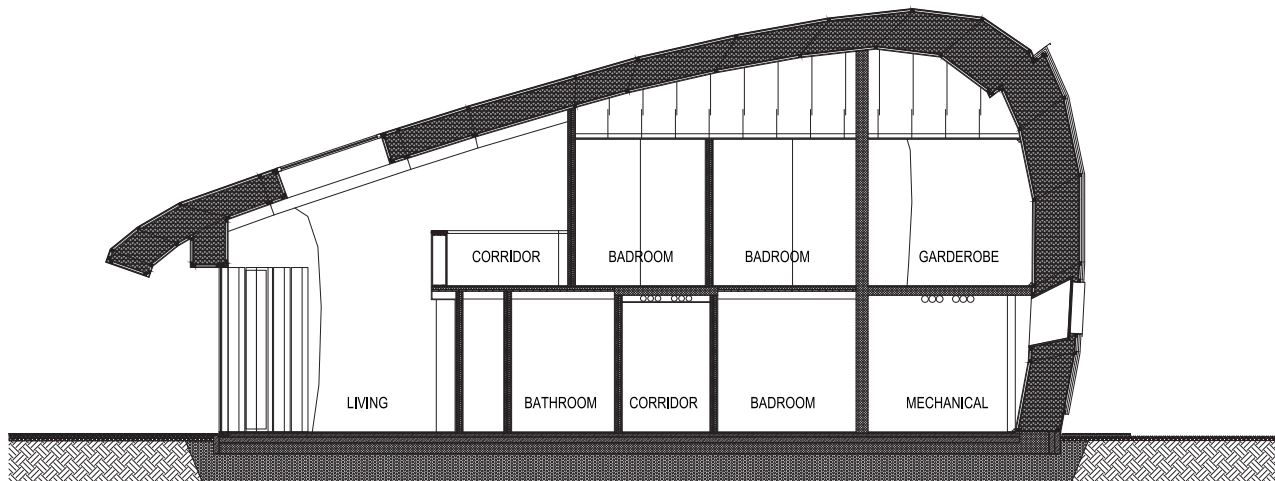
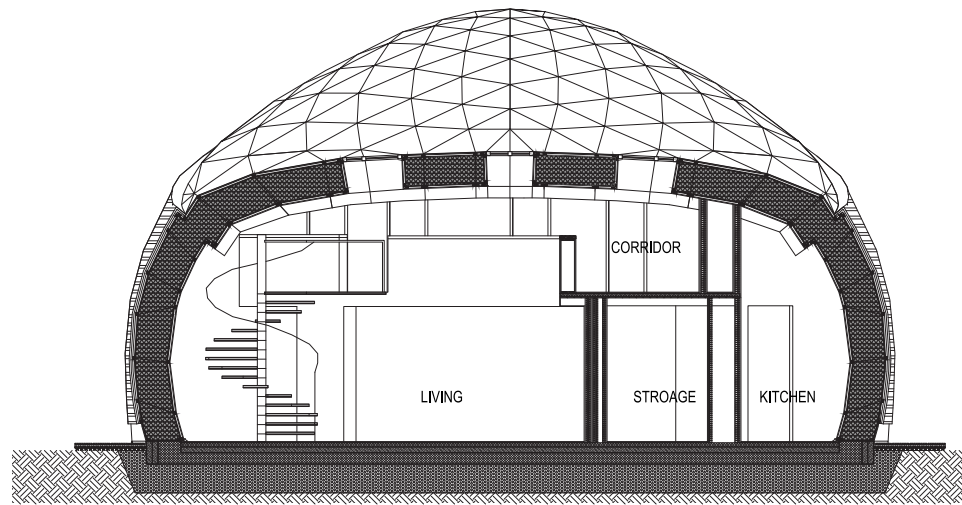

4.2 FREE FORM BUILDING 01 - GRAVEL HOUSE

This 185 sqm residence was designed for a family of four (parents and two children), based on passive-house technology. The location is Miercurea Ciuc, Romania, area of mountains with a +6°C annual average temperature. Planned

construction period: six months, middle of 2012. The five bedrooms, two bathrooms and other rooms are situated on the first and second floor, while the combined kitchen, dining and living room constitutes a floor-and-a-half high space. A double garage, a stor- age room and a rainwater storage are situated in a

separate volume with green roof, where solar panels can be installed.

In the presented application, the shell was modelled by five curved planes by scaling-offsetting the generator curved plane. The geometry of the layers, as well as the incision that holds the rainwater drainage pipes, were defined with this method.

To create a canopy, above the living room's exit, the shell was sectioned by a leaning plan.

Rainwater drainage pipes are hidden between the surfaces corresponding to „wall” and „roof” func- tions.

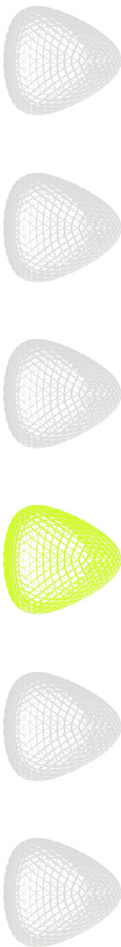
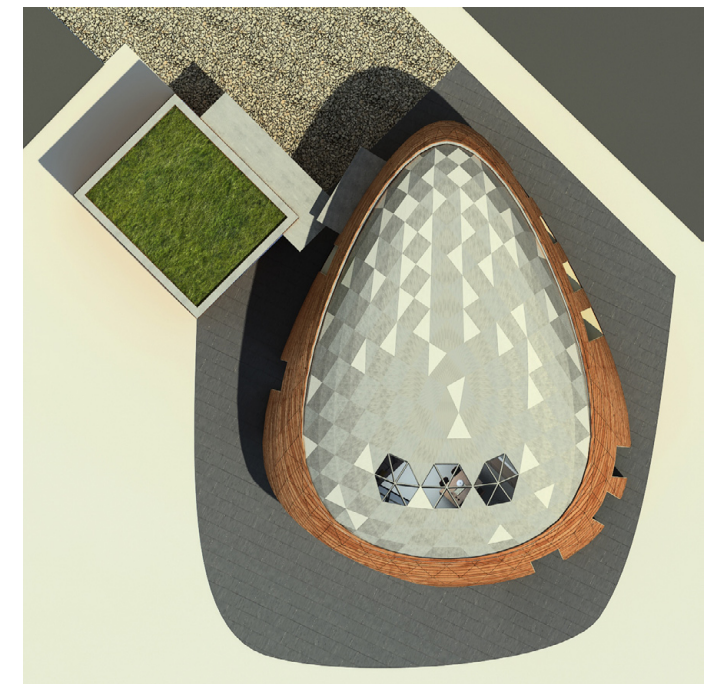

Example for shell layers:

- 24mm internal cover: 2 layers of gypsum board panel
- air gap between 30mm wooden slats, structure of the gypsum board panels
- vapour barrier, (air-tight plane of the building)
- 10mm OSB panel (internal shell)
- cellulose insulation in 450mm (variable) cavities, between parallelograms of 8mm OSB panel
- 10mm OSB panel (external shell)
- vapour permeable foil
- air gap between 30mm wooden slats, structure of the external cover
- 15mm, wooden boarding, external cover

Average width: 560mm

The thickness of the shell is dimensioned according to the energetic and structural reports.

In the internal air gaps the mechanical and electrical devices and their conductors are positioned, while the external air gap ensures the ventilation of the covering layers.

The air tight plan is realised on the external plan of the internal air gap, by the application of a vapour barrier. On the level of the roof, where the shell does not contain an internal air gap, the vapour barrier foil is positioned on the external plan of the internal OSB panel.

From the architectural point of view, the develop-

ment revises the shell of the building, offering the possibility to create ideal building shapes, gives **new opportunities** in the forming of volumes, in the creation of **free geometrical forms**.

In the presented project the external structure of the building is built by our method, generating a curved external shell made of small elements.

When mounting the elements of the structure, the accuracy of the construction can be controlled based on the 3D model.



Proprieties of the shell in our example (may be different in other structures):

- The result of the research is a multiple shelled cupola structure.
- The components are the panels of the inner and outer shell-planes and their connection elements, and the insulation filling the internal cells.
- The curved character of the structure is generated by the triangles of the outer surface, the connection is ensured by the internal connection panels.
- In our case the elements of the shell are of oriented standard board panels (OSB), the insulation material is cellulose.
- The connection of the panels is provided by wood

en slats, fixed by clinkers.

- The application method of cellulose insulation is similar to its application in conventional wooden structures: the material is blown into the cells through apertures on the shell panels, which are covered after the procedure.
- Conceptually, the basic layers of our structure are: external covering - air gap - internal structure of the shell with insulation-filled cells - air gap - internal covering.
- The external covering on the vertical plane is made of boarding, on the upper plans of metal sheets, the internal covering is made of gypsum board panels.
- Last but not least: the structure generates the

space and shape of the building, determining its architectural value.

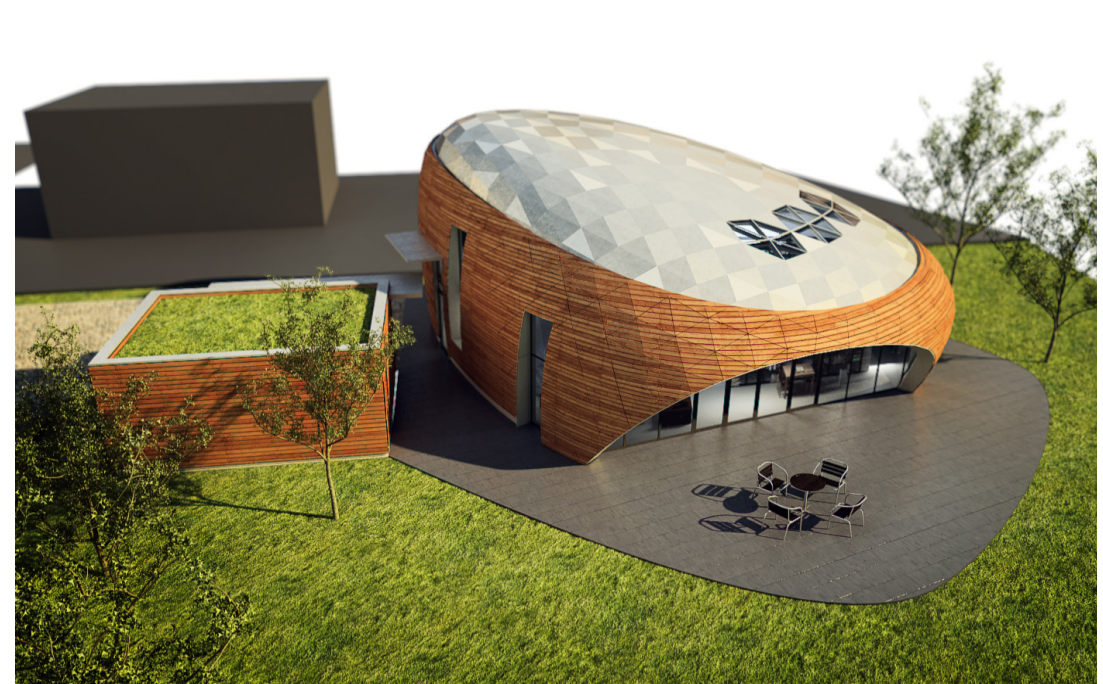

DETAILS

Wall layers

- plaster fill, painting
- 2 layers of 12,5mm gypsum board panel
- 48mm wooden slats, structure of the gypsum board panels, in between: air gap
- vapour barrier foil
- 10mm OSB panel
- 400mm (variable), 8mm OSB panel, in between: cellulose insulation
- 10mm OSB panel
- vapour permeable foil
- 48mm, wooden slats, structure of the external cover, in between: air gap
- 15mm, wooden boarding, external cover

Roof layers

- plaster fill, painting
- 2 layers of 12,5mm gypsum board panel
- 48mm wooden slats, structure of the gypsum board panels, in between: air gap
- vapour barrier foil
- 10mm OSB panel
- 450mm (variable), 8mm OSB panel, in between: cellulose insulation
- 10mm OSB panel
- vapour permeable foil
- 10mm OSB panel
- vapour barrier foil
- sheet-metal

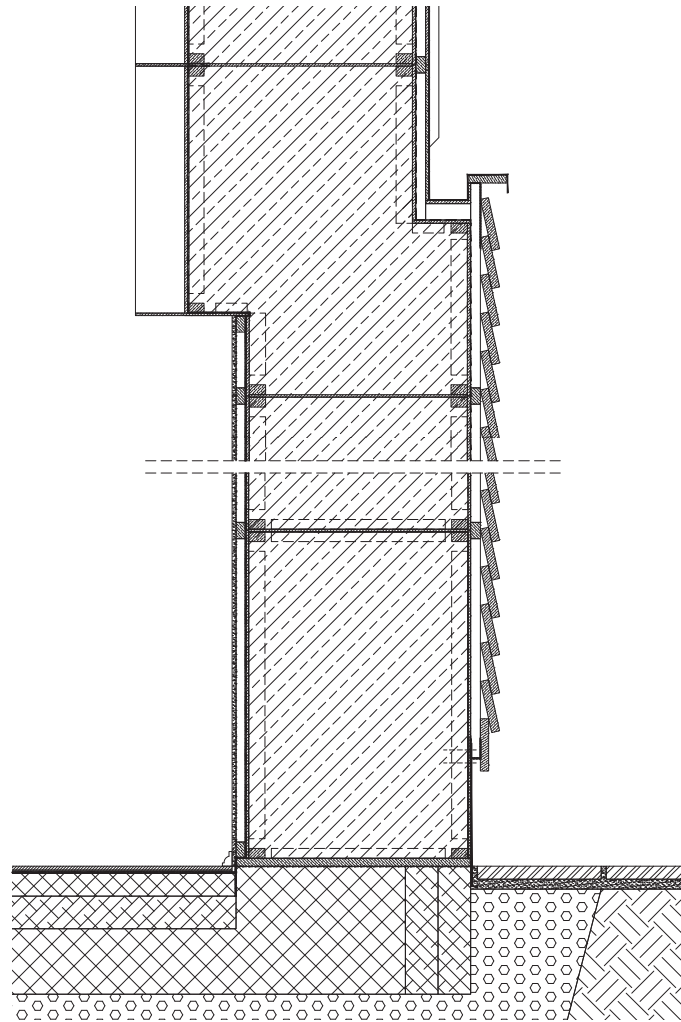

External thermo-shell sections on the basement, external wall and roof level.

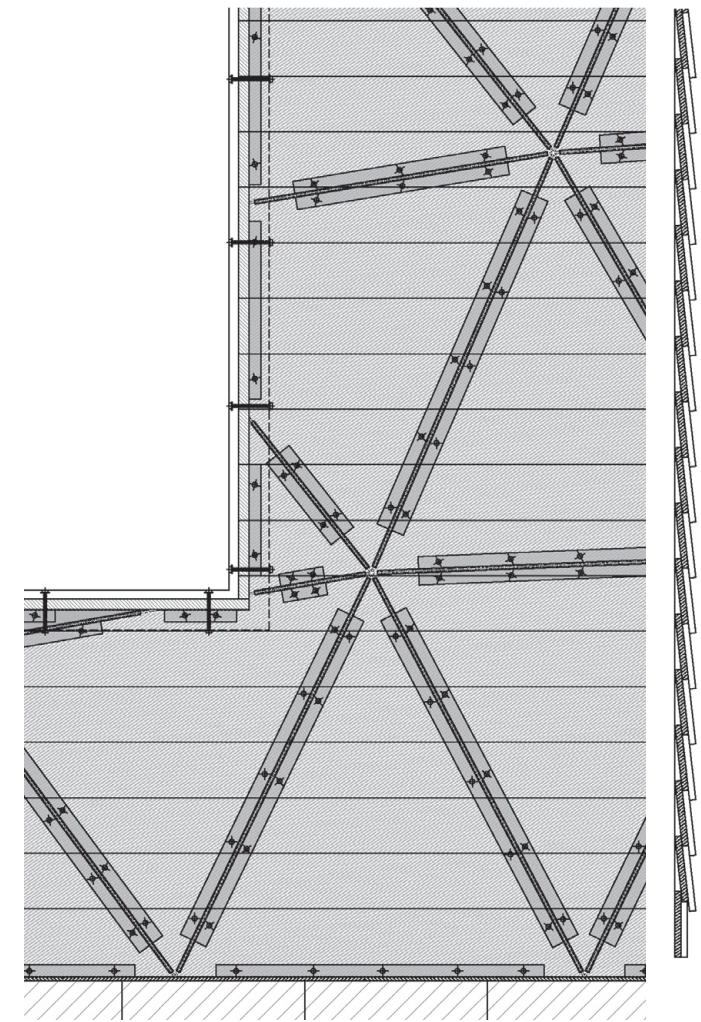

Front projection of positioning the structure elements with the finishing materials: OSB panel triangles, the wooden slats and the covering wooden board.

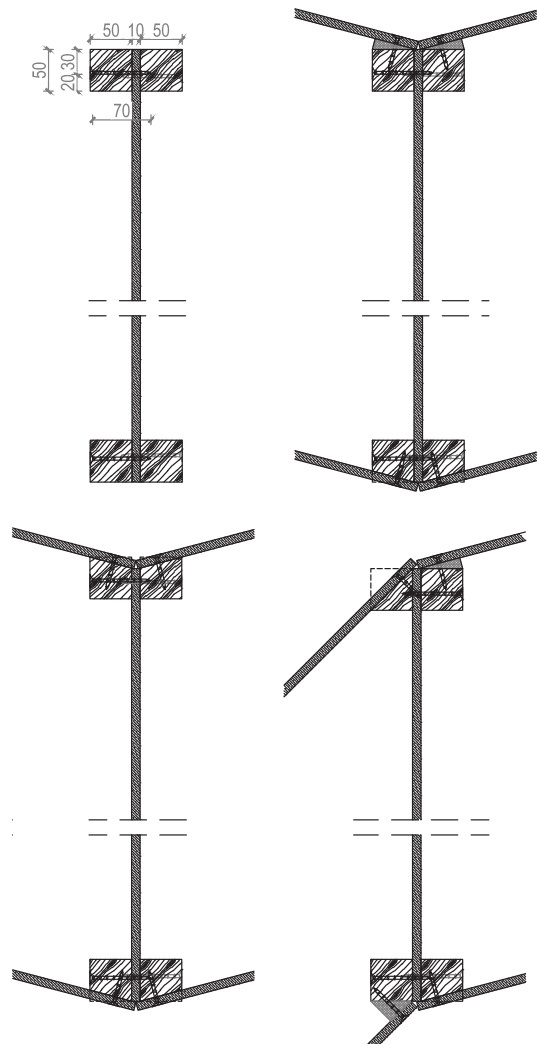

Different ways of connecting the two OSB panels through the wooden slats.

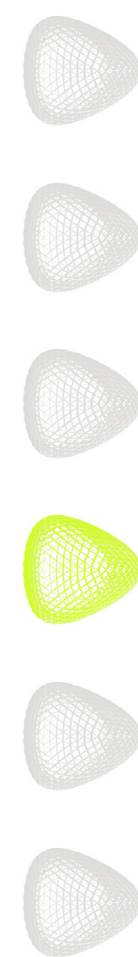

4.3 FREE FORM BUILDING 03 - FAMILY HOUSE

The third presentation building will be constructed in Nagykovácsi, near Budapest, in 2012. The building is designed for a four member family.

It contains -next by the living area- four bedrooms, two bathrooms and the atelier. The internal spaces are arranged in the living area in a high ground-floor above which is positioned the restaurateur atelier, the bedrooms and the service areas arranged on two levels. The plot is of 20 percent slope, therefore the external pathways are getting an accentuated role in the volumetric composition.

The main elements of this composition are the garage and storage at the entrance, the stairs of the pathway, the garden pond and the residential building.

The external covering is coloured bare shotcrete, applied on the multi layered shell of the „Free Form Buildings” cupola structure.

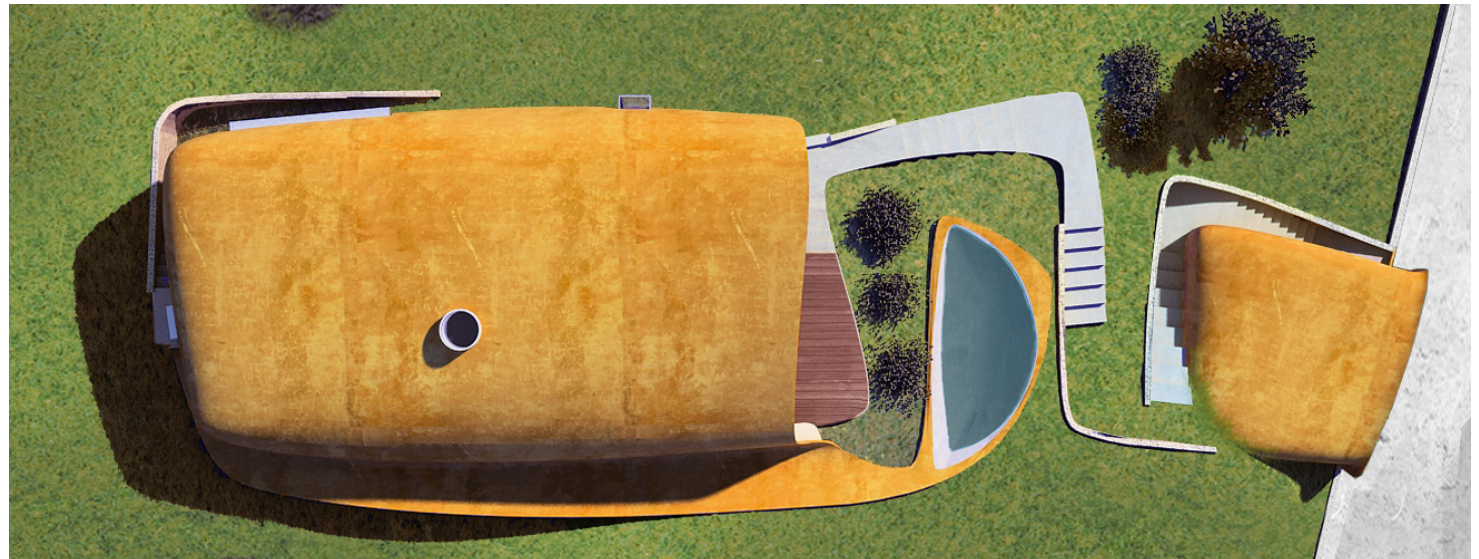
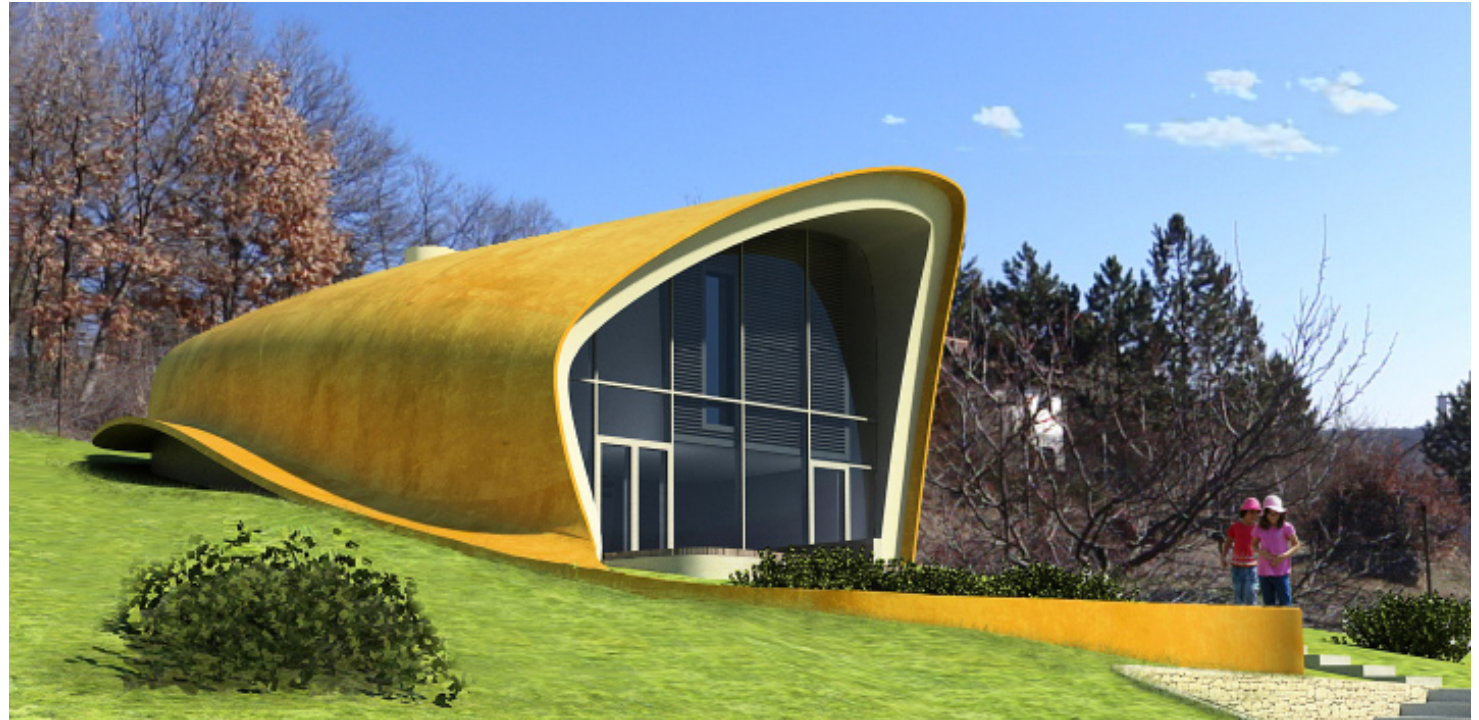

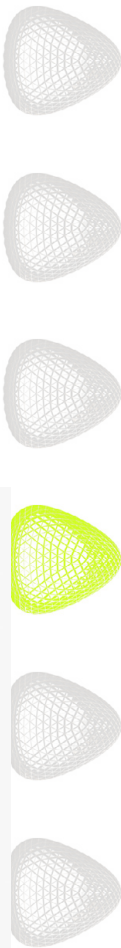
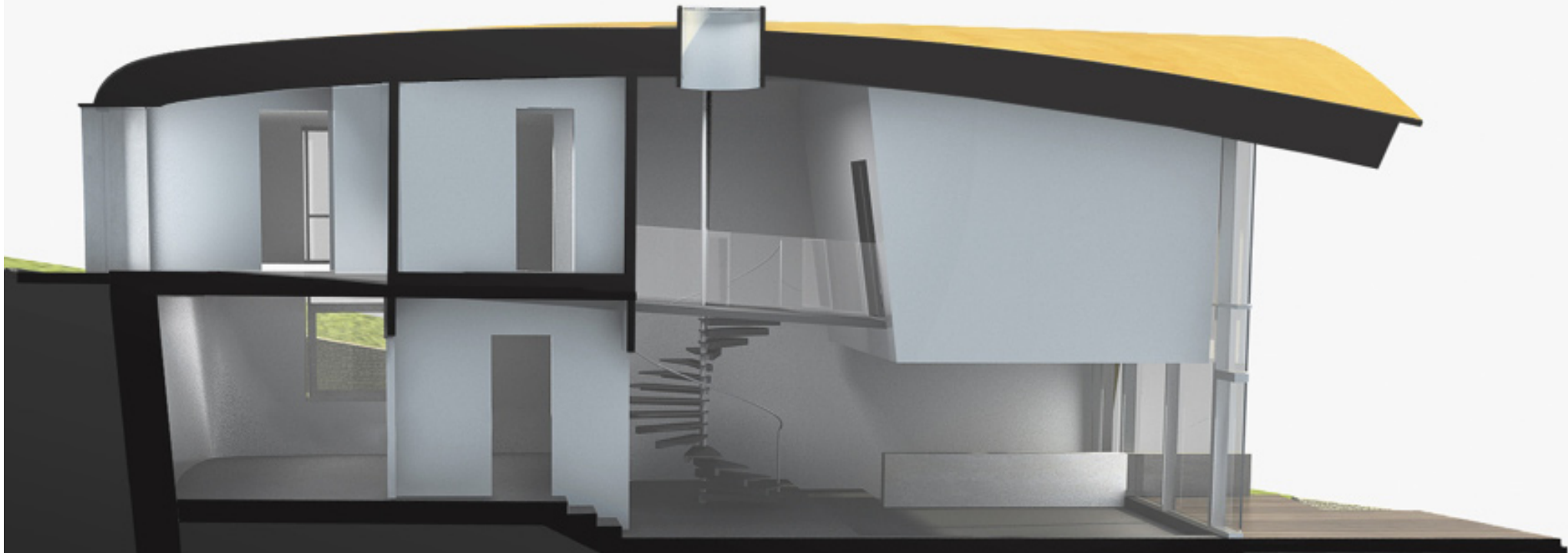
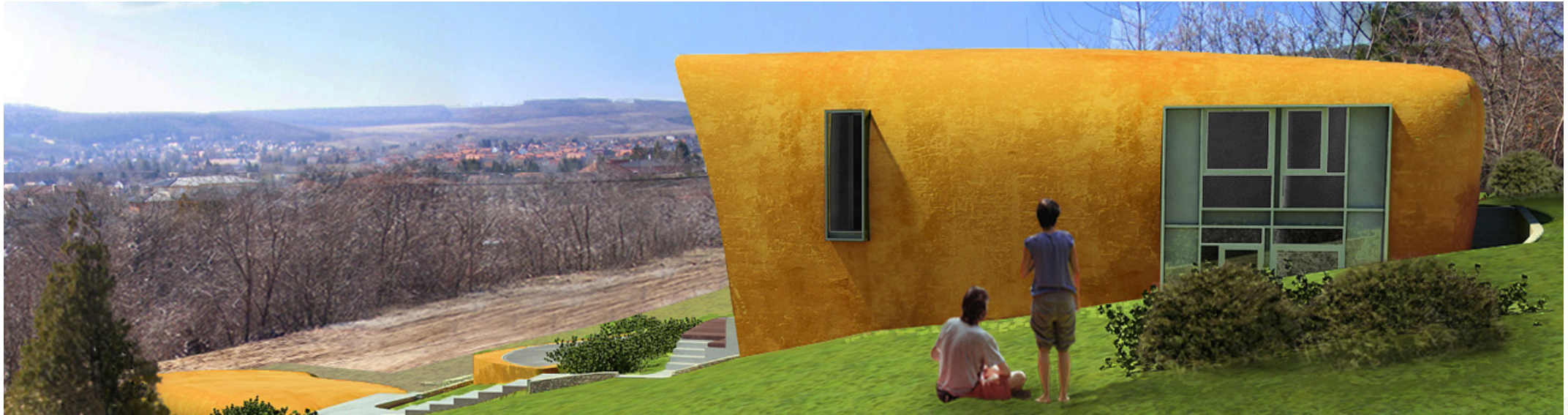

4.4 FREE FORM BUILDING 04 - SPORT HALL

 ur fourth presentation building's data page:
1. Name: Free Form Buildings 04
– multifunctional and sport hall

2. Location: Budapest, District 4, Káposztasmegyer

3. Client: Megyeri Tigrisek Basketball Club

4. Area: 9400 m²

5. Function: Multifunctional hall

6. Design stage: Under authorisation

7. Design team: Portik Adorján, Ertsey Attila, Nagy Gábor, Árva Péter

8. This project is the fourth application of the „Free Form Buildings” construction system. Based on the invitation of Ertsey Attila (Kor Építész Studio Kft.), we designed the geometry and the structure of the building.

The span of the structure is 70m, the thickness varies between 1,2 and 0,8m. The metal sheet external covering is switched to glass at the main entrance and the roof skylight, to introduce the natural light in the interior, but also to present the structure.

The two cross sections are different: on the joint between the external wall and roof plane on of the is sharpened in console to exterior and the second section is flattened, by this we assign to the building volume a wavering dynamism at this rounded junction line.

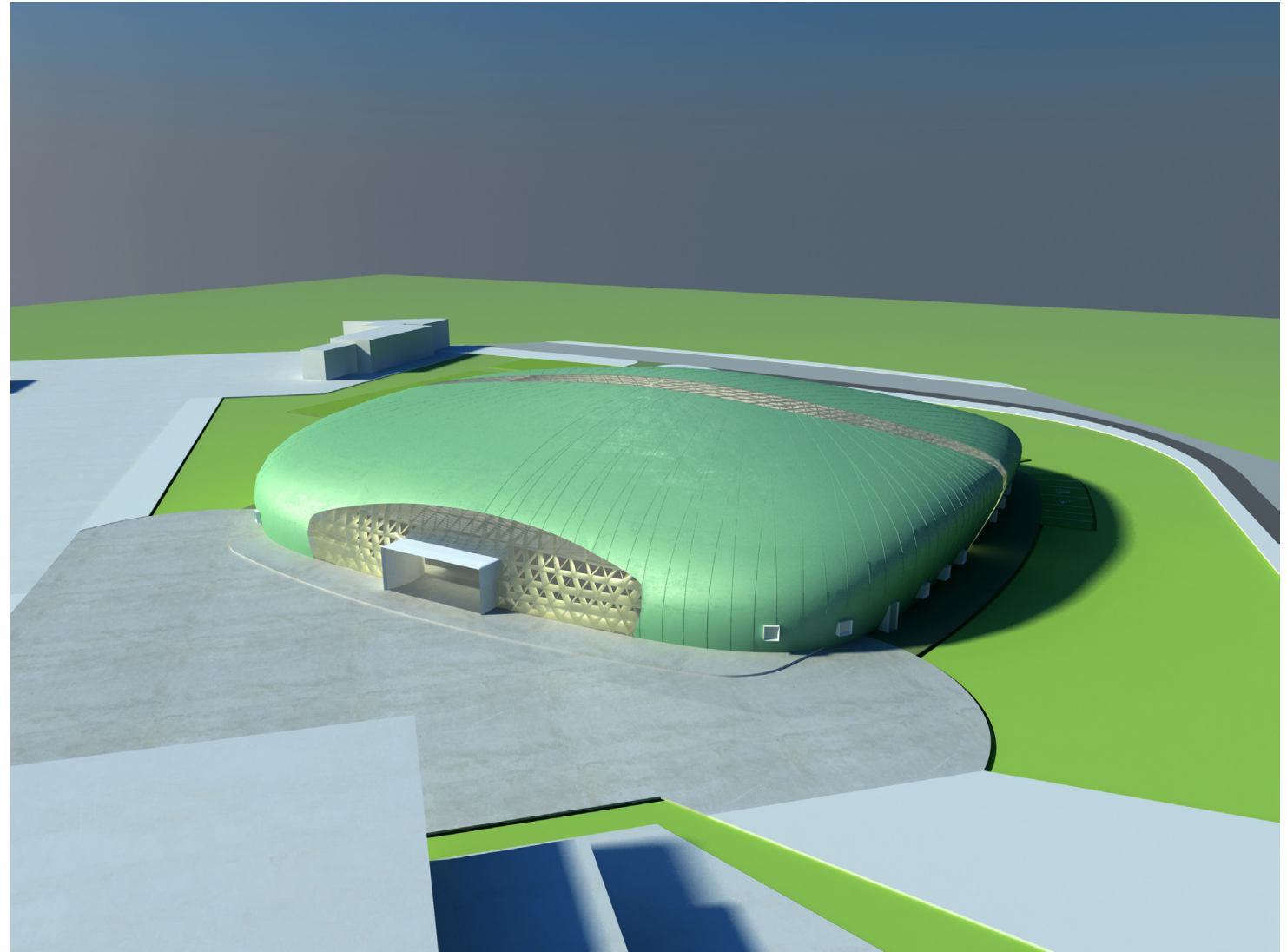

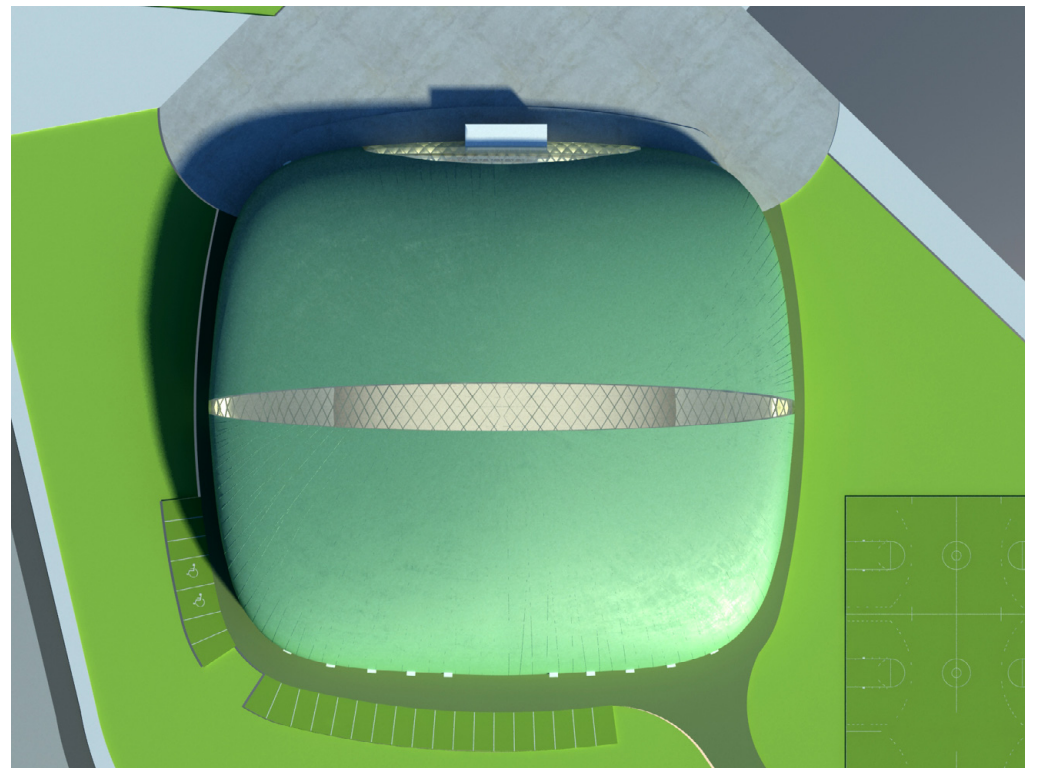
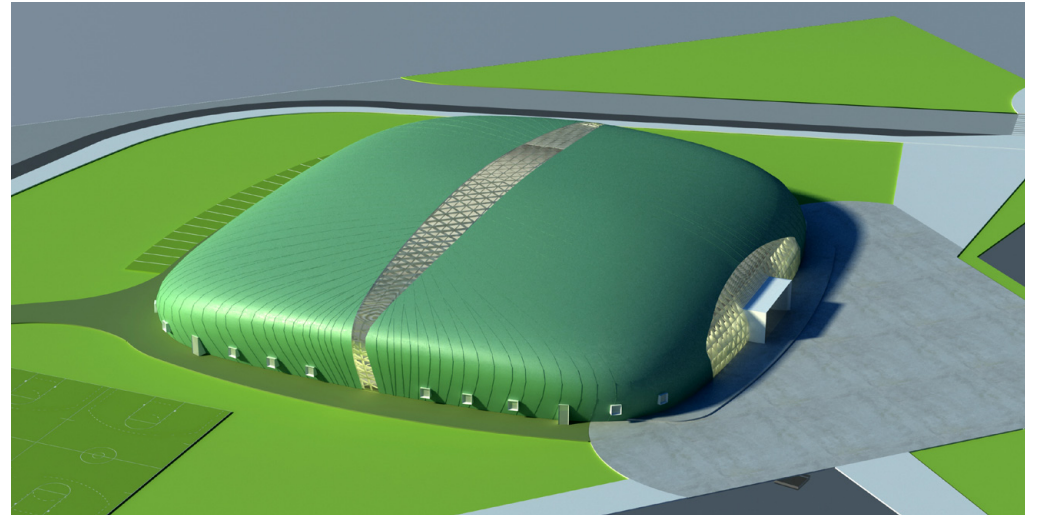
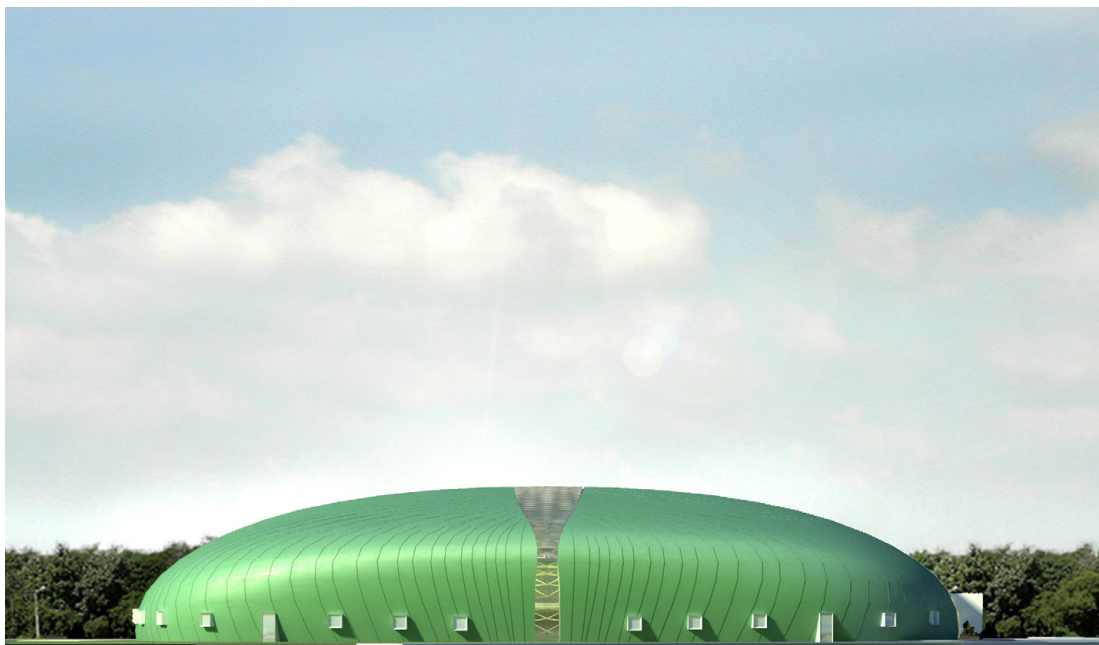
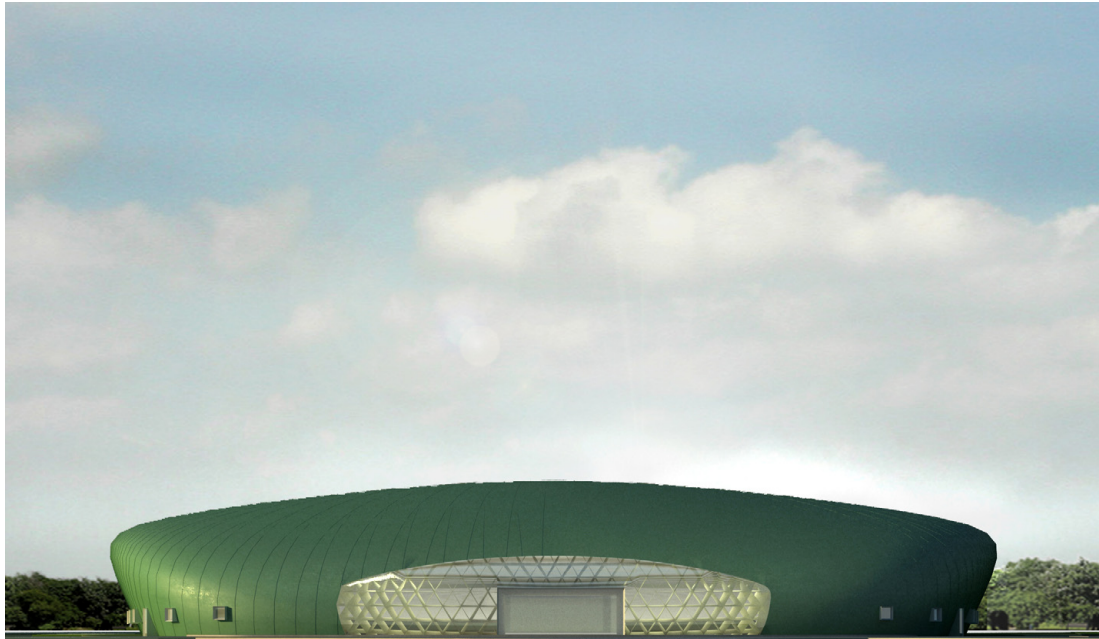

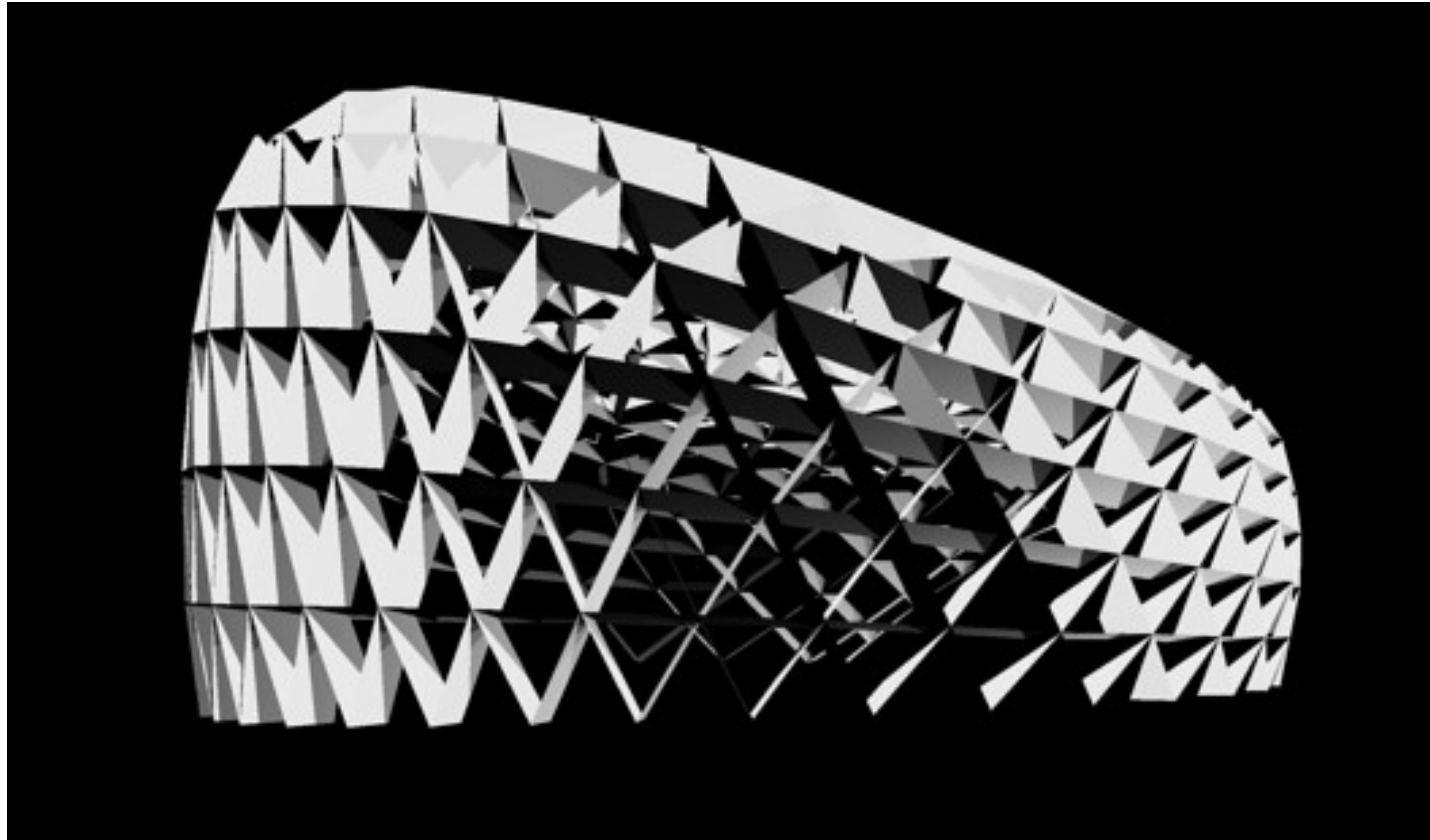

polyhedron. The connection elements of the shells are defined last.

- Using 3D design, the geometry of the components is **precisely defined**, making adequate documentation possible.

- By modifying the size and sum of the panels of the shell, we can accent or moderate the connections, so as to accent or moderate the curved character.

- Openings on the shell can be made by either removing cells or by introducing incisions with different geometry.

- As the structure does not have external corners, we meet wider possibilities to position openings achieving good natural illumination or in consideration of external views.

- The structure can be connected to any other differently shaped structure and modelled – in this case as well – as desired.

5.1 GEOMETRY

The shape of the structure can be modelled in **any direction**: convex or concave, curved or flat surfaces can be generated during the design process.

- The technology offers an easy method for the generation of building shapes.

- The number of the shells is variable, we can generate multi-layered internal cells to position installations, their cables, insulation, ventilation gaps, or

we can apply the system for casting concrete based structures. (See the patent description for multi-shelled structures)

- The design of the construction can be aided by computer software: at concept level we create **multi-curved surfaces**, then the final shape is transformed into regular or irregular polyhedrons, the surface modelled with polygons. The other shell planes are generated by changing the scale of the original

5.2 ENERGETICS

The energetic report of the family house was prepared with PHPP software, which is indispensable in the passive house license.

- According to this report, due to the properties of the external structure, the expected heat energy consumption is **11 kWh/m²** annually, which is a notable achievement, regarding the size of the openings and the 5°C annual average temperature of the region.

- The insulation properties of the shell are advantageous for the use of low-energy heating and cooling systems, such as heat recovery ventilators, by which up to 90% energy saving can be attained – compared to usual energy needs.

- The curved external surface facilitates the positioning of glass surfaces in order to maximise solar heat gain, the importance of which has increased in the case of green buildings with high “U”-valued structures.

- Regarding internal air circulation, as the volume of the internal air can be smaller, it is easier to heat, consequently less energy is required for the heating. In comparison to rectangular surfaces, the covering materials of the curved surface have a higher mechanical resistance due to the lack of corners; in absence of the external air-vortexes the heat exchange of the external covering is slower.

- Less material is needed to build the external shell of a space than in the case of vertical and horizontal structures.

- Since the insulation layer is not separated from the load-bearing layer, the thickness of the external structure can be more advantageous – smaller – than of a traditional structure with the same insulation properties.

Passivhaus Nachweis IGAZOLAS PHPP-2007.



Épület:	PASSZIVHÁZ	
Helyszín és klíma:	Csobotfalva - ROMÁNIA	
Utca:		
Helyiség / Város:	Csobotfalva	
Ország:	ROMÁNIA	
Épület típus:	családi ház	
Építető (k):	Szász család	
Utca:		
Helyiség / Város:		
Építész:	Portik Adorján okl.építész	
Utca:		
Helyiség / Város:		
Építésgépezet - tervező:	Benécs József	
Utca:	Blaháné út 50	
Helyiség / Város:	Gödöllő	
Építés éve:	2010	
Lakóegységek száma:	1	Belső hőmérséklet: 20,0 °C
Béépített térfogat V _e :	614,9 m ³	Belső hőforrások: 2,1 W/m ²
Személyek száma:	4,0	

Energiahatékonysági felületekre vonatkoztatott jellemzők			
Energiahatékonysági felület:	184,8 m ²	Éves eljárás: 11 447	PH-Zertifikát: <input type="checkbox"/> Teljesül ?
Fűtési hőenergiaigény:	11 kWh/(m ² a)	15 kWh/(m ² a)	<input checked="" type="checkbox"/> ja
Légtömörésvizsgálat eredménye:	0,6 h ⁻¹	0,6 h ⁻¹	<input checked="" type="checkbox"/> ja
Össz. primerenergia-mutató (HMV, fűtés, vill. segédenergia, háztartási áram):	68 kWh/(m ² a)	120 kWh/(m ² a)	<input checked="" type="checkbox"/> ja
Primerenergia-mutató (HMV, fűtés, vill. segédenergia)	32 kWh/(m ² a)		
Primerenergia-mutató Soláris áramtermelés megtakarítása:	kWh/(m ² a)		
Fűtési hőszükséglet:	15 W/m ²		
Túlemelegedés gyakorisága:	6 %	25 °C felett (Túlemelegedés)	
Hűtés fajlagos energiaigénye:	kWh/(m ² a)	15 kWh/(m ² a)	<input type="checkbox"/>
Hűtés energiaigénye:	17 W/m ²		

Mutatók az EnEV szerinti hasznos területre vonatkoztatva			
Hasznos alapterület az EnEV szerint:	196,8 m ²	követelmény:	Teljesült ?
Primerenergia mutató (HMV, Fűtés, vill. segédenergiaigény):	30 kWh/(m ² a)	40 kWh/(m ² a)	<input checked="" type="checkbox"/> ja

Biztosítjuk Önöket arról, hogy a fenti számítás során a PHPP eljárásnak megfelelően jártunk el. A PHPP alapján történő számítások a MINŐSÍTÉS mellékleteként kerülnek átadásra.

Kelt: 2010.04.23 10:25
Aláírás:

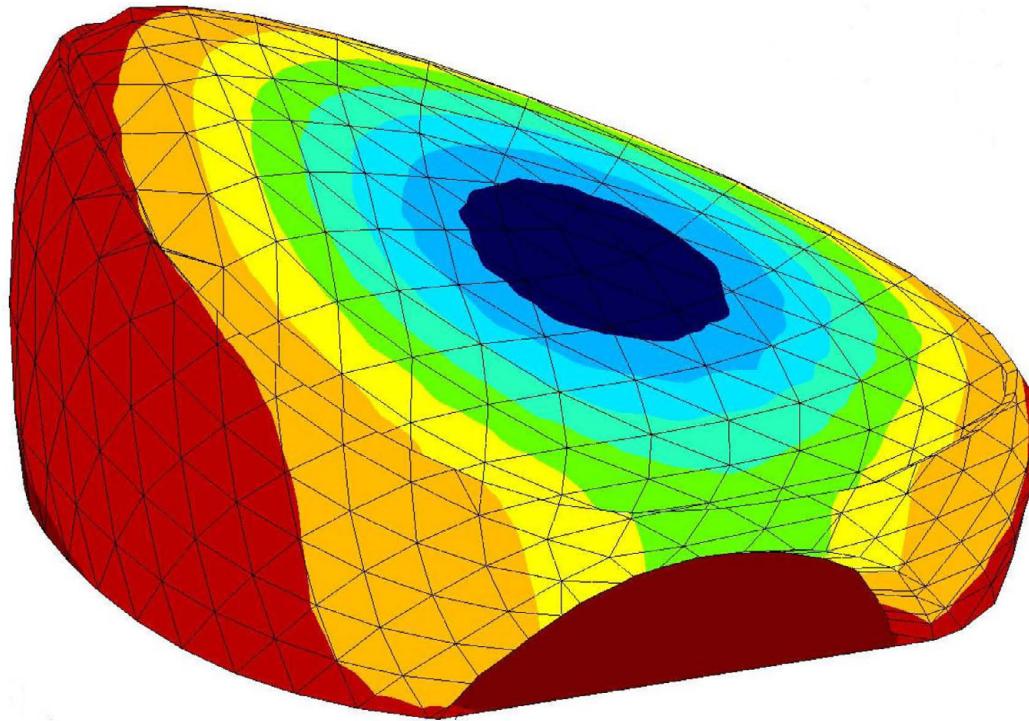

5.3 STATICS

Because of the advantageous positioning of the elements, the construction method is ideal for the building of supporting or self-supporting structures as slabs, bridges, walls, canopies or balustrades.

- The primary factors in the determination of thickness are the structural and heat-exchange demands.
- The self supporting - freely formed - cupola does not require external structural wall or colonnade.

shotcrete layer.

- Using our procedure, we are able to build statically more advantageous structures compared to the conventional light structured buildings of the same mass of materials or same size.
- The **multi-shelled cupola** is very advantageous from the aspect of resistance: in the case of the presented project the static report has confirmed that it is a **light and strong structure**.

- As for the openings, the tensions of the structure are received and transmitted by statically appropriate frames, the contour of which can be designed with or without reference to the connection edges.
- The connection of the walls and the roof does not need structural consideration, as structurally these two functions are integrated.
- The structure can be applied as form-work for reinforced concrete structures, either by filling the inner cavities with concrete (using connecting parallelograms with openings in them) or by covering the structure with a wire mesh and applying a

- The structure of this residential building – due to its location – was dimensioned calculating with a snow load of 300 kg/m²; seismic loads have been also taken into consideration. The most significant deformation of the structure is the vertical one, the value of which was 45 mm under 3,2kN/m² live load + self weight multiplied by the relevant safety coefficients, on the span of 17,5m.
- The fixation of the connections by tack screws were also determined and controlled by structural calculations.
- The structure's resistance can be increased by the addition of new layers to the shell or by using it as form-work for a reinforced concrete structure. We have to emphasise that in our studies the thickness of the shell was determined by the necessary thickness of thermal insulation rather than the loads.
- When designing the structure, we endeavour to form an approximate catenary arch, so that we can keep stresses within the structural plane. This way, its maximum span is about **30m** with point-fixed nodes (using bolts or nails) and more than **100m** using adhesives as well for fixing.

5.4 ENVIRONMENTAL

In the presented project, the component materials of the shell are oriented standard board panels – as structure –, and cellulose – as insulation.

In the fabrication of these panels, the whole section of the pine is used, except of the bark, resulting in minimal waste production.

Young trees and faster growing species are also used.

The adhesive used in the production is made of wax and resin, the emission of formaldehyde is very low, 10% of the permitted value.

The cellulose insulation is made from recycled paper (80%), as well as from cotton, straw, sawdust, hemp and corncob, during the application, waste is not produced.

The construction system facilitates energy efficient design and the application of environmentally friendly technologies.

The construction process (cutting and fixing of the elements by tack screws) demands **low technological involvement** with relatively **small energy consumption**.

The components – in case of demolition – are recyclable or decomposable, noxious substances are not produced, the quantity of steel and reinforced concrete elements is small.

Due to the favourable insulation properties of the thermic shell and the use of heat recovering ventilation system, energy consumption of heating and cooling is at least 90% less in the designed building than in one built with traditional construction methods. The building meets the standards of the Pas-



sive House Institute.

Mechanical ventilation is recommended – and indispensable to comply with passive house standards – as it not only reduces energy consumption of heating and cooling, but it also significantly improves inside air quality thanks to the higher ventilation rate.

Inside air is replaced by fresh air filtered of dust and pollen at least twice a day.

The components of the structure are prefabricated, so we do not produce waste on the construction site, and the process of fabrication is more controllable.

5.5 APPLICABILITY

The multi-shelled cupola, due to its advantageous structural qualities, is applicable for multilevel buildings, even though it is a lightweight structure.

The structure is applicable, without any functional restriction, as the external shell of a building.

From a volumetric point of view, it can be applied as either one-storey or multilevel edifices.

Since the connections can also be fastened with screws, the construction method is appropriate for the realisation of temporary buildings: by simply **mounting and dismantling** the relatively small elements, efficient relocation of the structure is possible. As it is economical regarding the use of energy for heating and cooling, there are no geographical restrictions in the positioning of the building.

Even if the structure is most advantageous as a free-standing volume, if there are adjacent walls, it can be used to model the façades and roof planes.

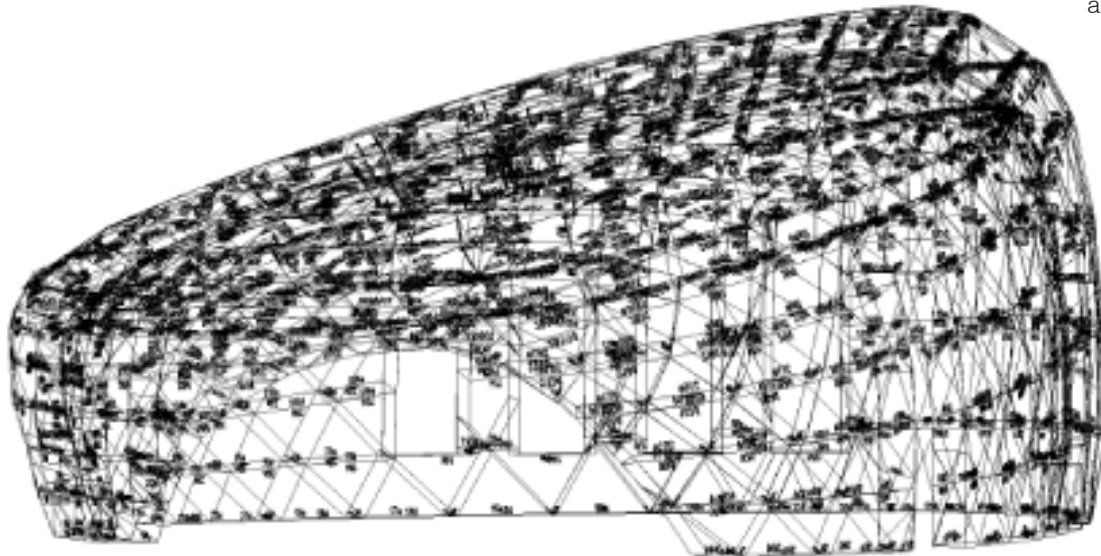

The prefabrication of the elements also facilitates **mass production**, however, better building performances can be achieved if one takes into consideration the immediate environment (neighbouring volumes, orientation, vegetation, etc.) of the house to be constructed.

By using impermeable foils on both the internal and external plane, only a negligible amount of humidity permeates the structure, which does not diminish its static resistance or worsen the insulating properties of the cellulose. The expected effects on the construction processes, the possible expansion in the construction field:

- Increased use of insulation is available by the presented system, therefore the application of the method is expected in the field of the **energy sensitive buildings**.
- The applied components and technology facilitate the construction of energy efficient and environmentally friendly buildings, accordingly the development is to be expected in the field of green family houses.

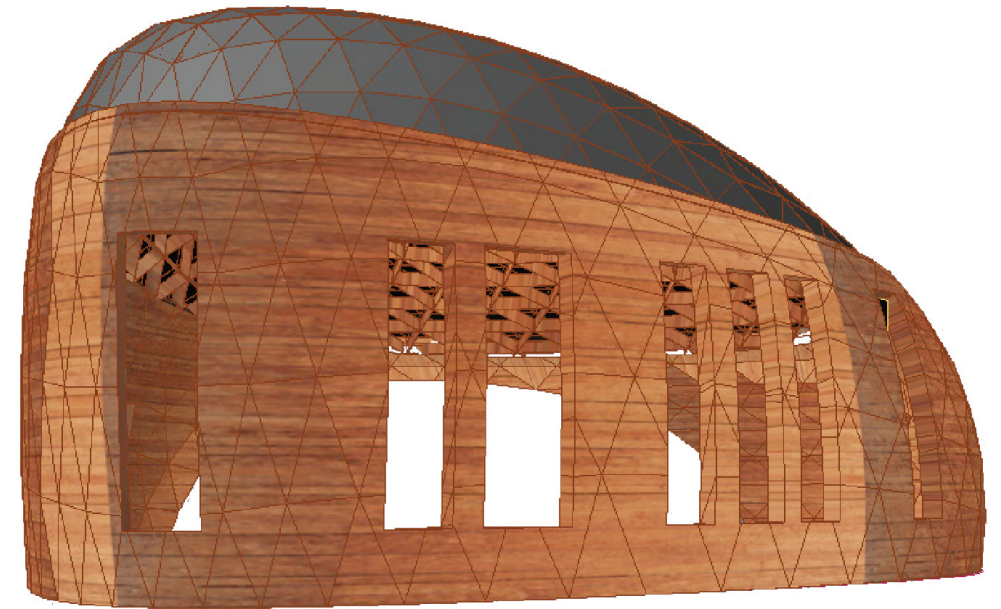

- In smaller dimensions, the system is applicable as a design element for constructions such as roofs, arcs, or canopies and pergolas.
- Regarding cost efficiency, the construction method can also be used in the realisation of **prefabricated and temporary constructions**. To mount the structure on site, special technology or devices are not needed.
- Our construction method is a proposal concerning the structure of buildings. On the internal and external surfaces any current cladding materials can be applied, using their relevant fixing technologies.
- Attics can be more rationally used in comparison to peaked roofs, as there are no dead spaces typical of the latter.

5.6 PERFORMANCE EVALUATION

a. FFB thermic shell

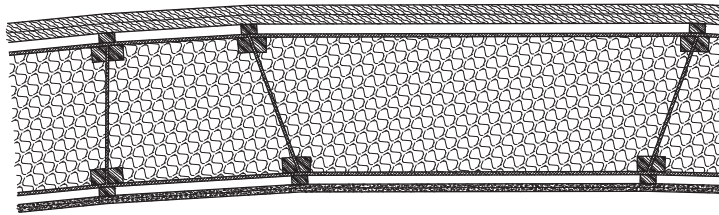

0m 0,2m 0,5m 1m

b. Brick based thermic shell

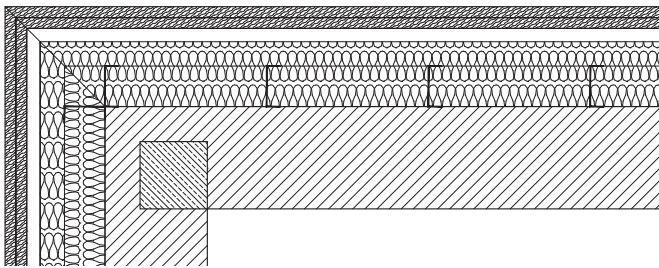

c. Timber structured thermic shell

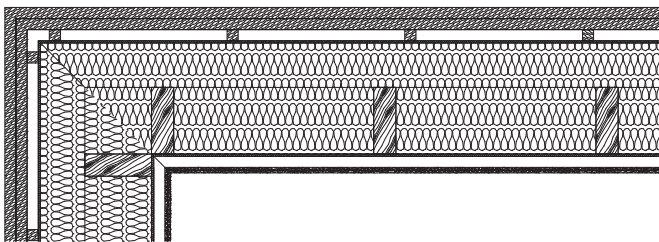

Wall layers

- plaster fill, painting
- 2 layers of 12,5mm gypsum board panel
- 48mm wooden slats, structure of the gypsum board panels, in between: air gap
- vapour barrier foil
- 10mm OSB panel
- 400mm (variable), 8mm OSB panel, in between: cellulose insulation
- 10mm OSB panel
- vapour permeable foil
- 48mm, wooden slats, structure of the external cover, in between: air gap
- 15mm, wooden boarding, external cover

Wall layers

- 20mm plaster, painting
- 380 mm brick with reinforced concrete columns enhancement
- 240 mm insulation
- vapour permeable foil
- 48mm, wooden slats, structure of the gypsum board panels, in between: air gap
- 15mm, wooden boarding, external cover

Wall layers

- plaster fill, painting
- 2 layers of 12,5mm gypsum board panel
- 48mm wooden slats, structure of the gypsum board panels, in between: air gap
- vapour barrier foil
- 10mm OSB panel
- 500mm wood columns (300+200), in between: 500mm thermo insulation (300+200)
- 10mm OSB panel
- vapour permeable foil
- 48mm, wooden slats, structure of the external cover, in between: air gap
- 15mm, wooden boarding, external cover

Roof layers

- plaster fill, painting
- 2 layers of 12,5mm gypsum board panel
- 48mm wooden slats, structure of the gypsum board panels, in between: air gap
- vapour barrier foil
- 10mm OSB panel
- 450mm (variable), 8mm OSB panel, in between: cellulose insulation
- 10mm OSB panel
- vapour permeable foil
- 10mm OSB panel
- vapour barrier foil
- sheet-metal

Roof layers

- plaster fill, painting
- 2 layers of 12,5mm gypsum board panel
- vapour barrier foil
- 300mm wood sloping beam, in between: 300mm thermo insulation
- vapour permeable foil
- 48mm wooden slats, in between: air gap
- 10mm OSB panel
- vapour barrier foil
- sheet-metal

Roof layers

- plaster fill, painting
- 2 layers of 12,5mm gypsum board panel
- vapour barrier foil
- 300mm wood sloping beam, in between: 300mm thermo insulation
- vapour permeable foil
- 48mm wooden slats, in between: air gap
- 10mm OSB panel
- vapour barrier foil
- sheet-metal



We compare our construction method (a.) – on a scale proposed in chapter 5.3, that is, on the scale of a family house – with the two most widely used construction systems of external wall structures: a clay brick wall strength-

ened with reinforced concrete columns and thermally insulated on the outer plane (b.) and a classic „lightweight” structure made of wooden beams and thermal insulation between them (c.). All three cases are representative samples with the

same areas and functional arrangement, and the same thermal insulation properties, complying with passive-house requirements.

a. FREE FORM BUILDING THERMIC SHELL

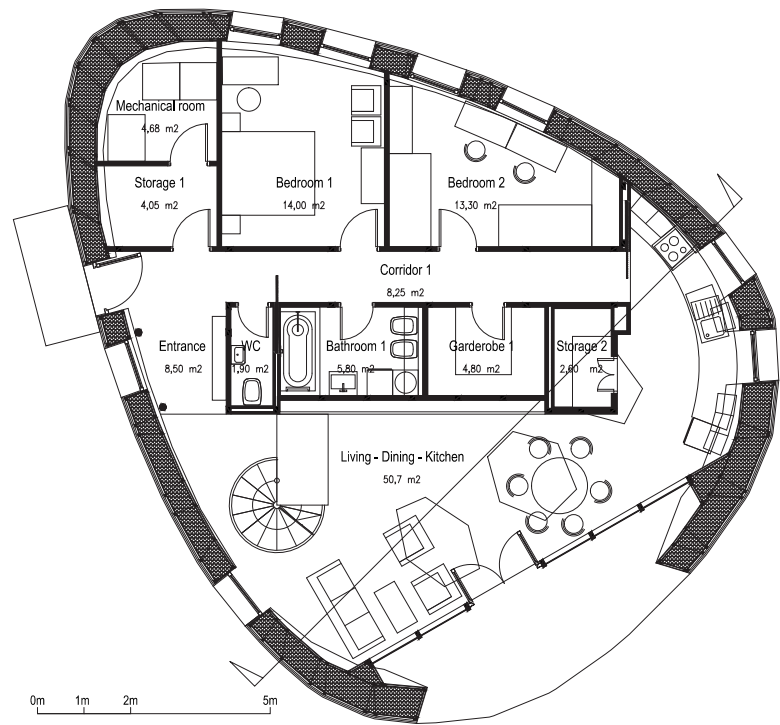

Groundfloor

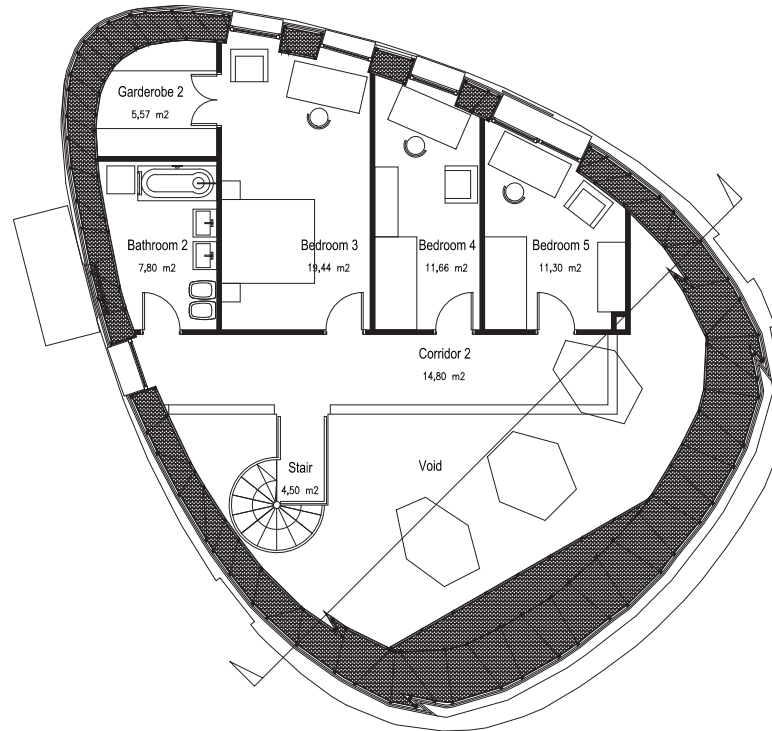

1st level

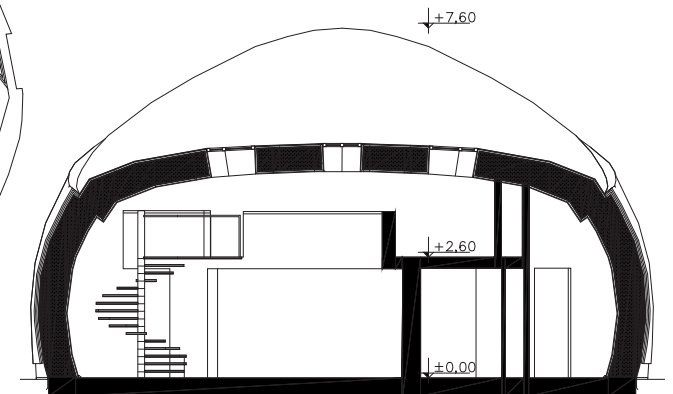

Section

b. BRICK BASED THERMIC-SHELL

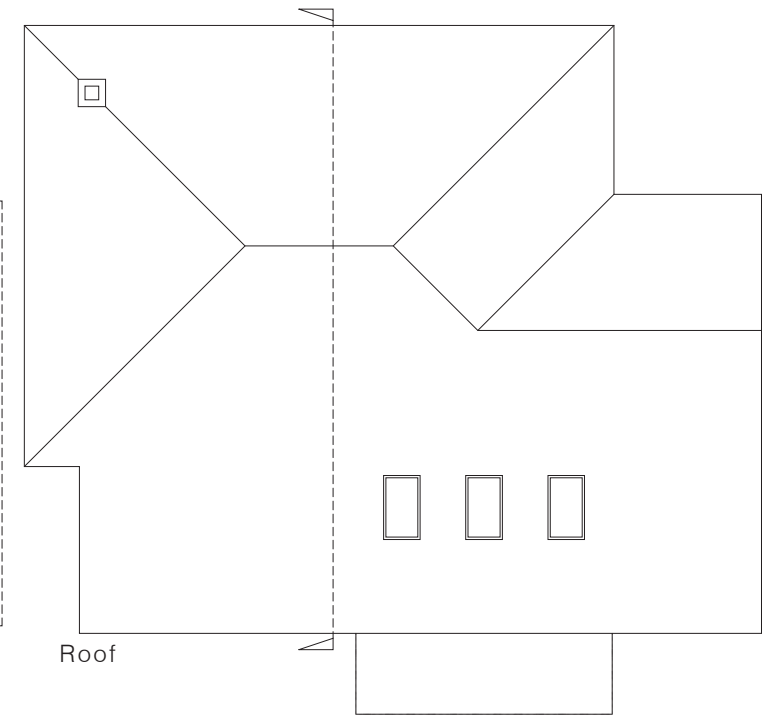
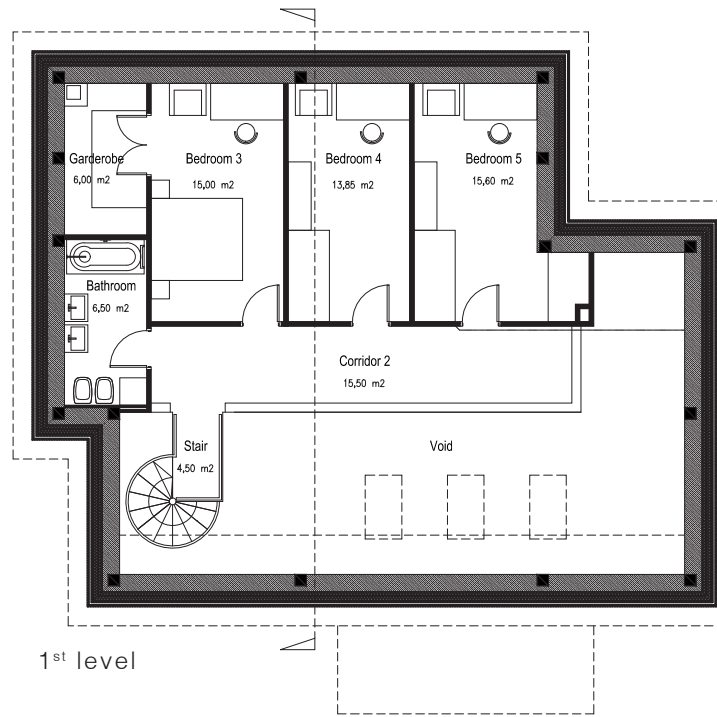
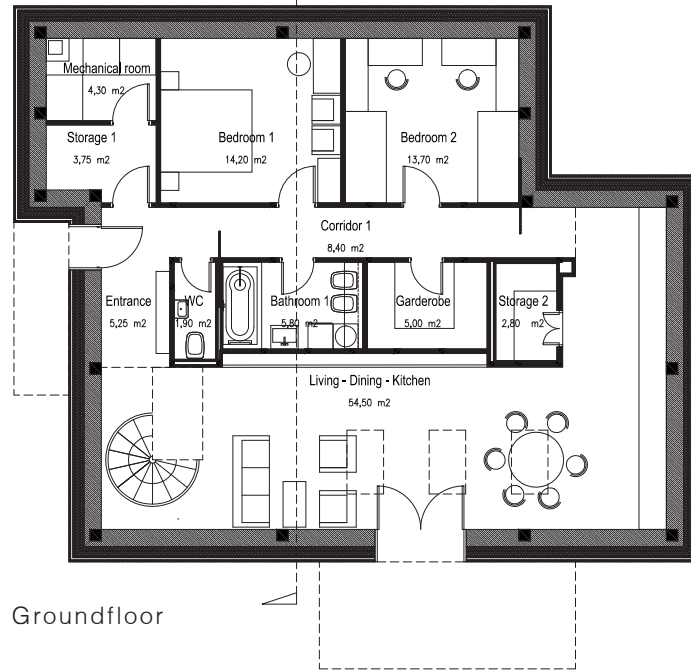

c. TIMBER BASED THERMIC-SHELL

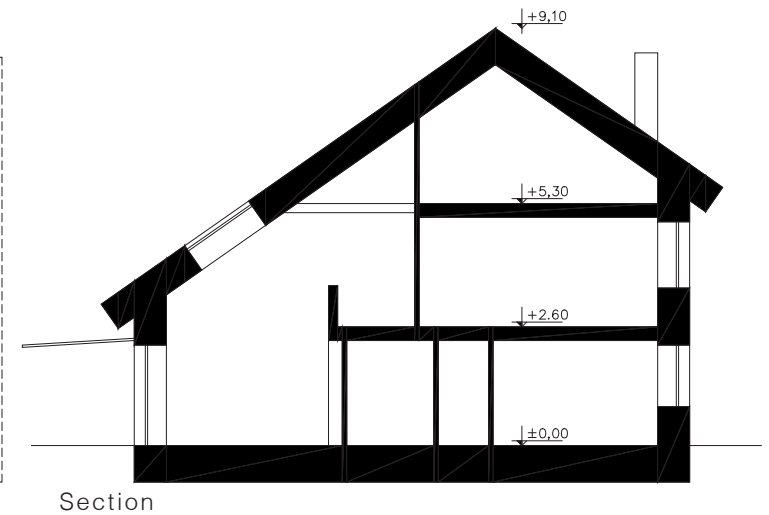
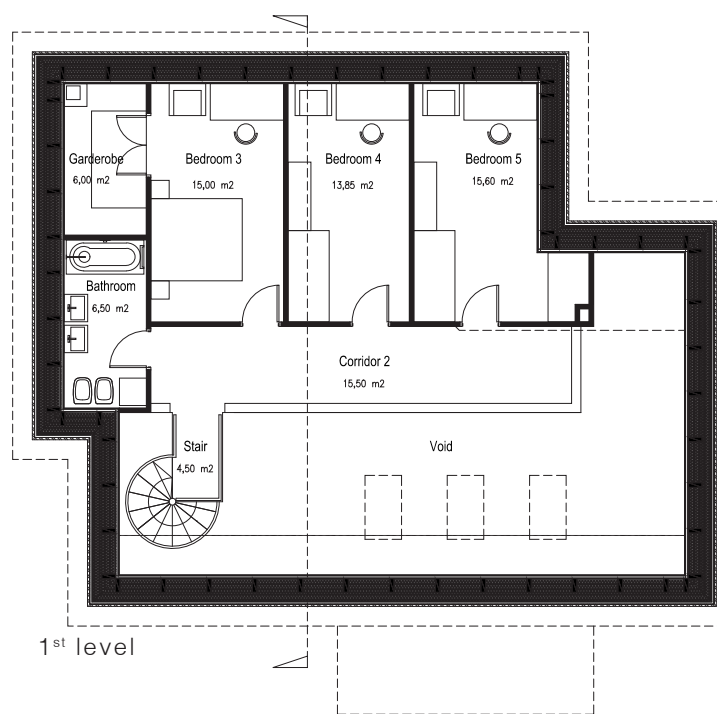
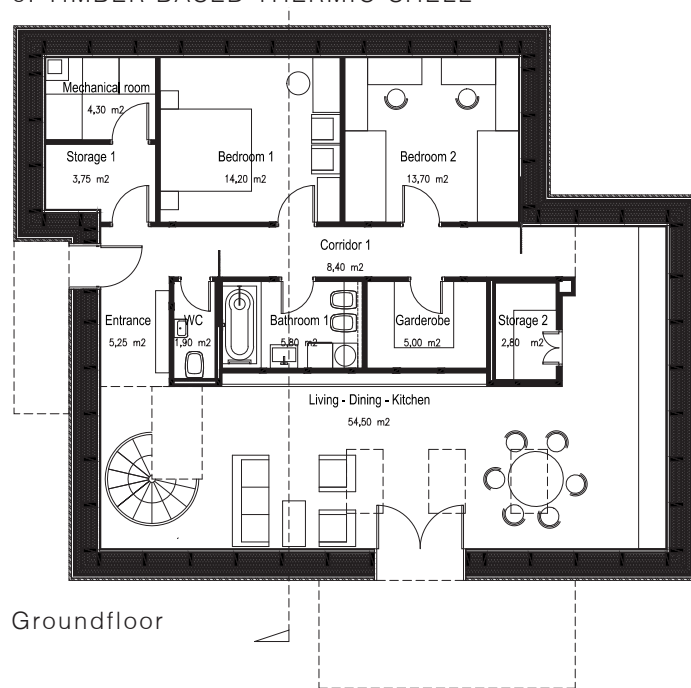

Performance Categories and Criteria	a. FFB	b. BRICK	c. WOOD		a. FFB	b. BRICK	c. WOOD
1. Functional Performance				5. Social Performance			
Space suitability and usability (size, mix, layout, location)	identical			Comfort and health	identical		
Space clarity (separation, demarcation, zoning)	10/10	9/10	9/10	Thermal comfort (temperature, movement, humidity)	10/10	9/10	10/10
Space efficiency, capability and capacity (e.g. Internal circulation)	10/10	8/10	8/10	Air quality (freshness, contaminants, smoke, exhausts)	identical		
Service life (building components and technical systems)	9/10	9/10	10/10	Views to outside, Daylight	10/10	8/10	8/10
Noise protection / Acoustic performance	identical			Lighting and glare	identical		
Flexibility / Adaptability / Variability	10/10	7/10	8/10	Acoustics	10/10	9/10	10/10
Site amenities (parking, recreational spaces, etc.)	identical			Vibration	10/10	8/10	9/10
Availability, support and potential of technical systems and installations for processes (power & water supply, lighting, alarms, IT, HVAC)	10/10	9/10	9/10	Signage, way finding and orientation	10/10	7/10	8/10
Sum	9,8/10	8,4/10	8,8/10	Privacy	8/10	10/10	9/10
2. Technical Performance				Cleanliness (site, building, interior spaces, fittings, fixtures)	identical		
Load bearing capacity (structure / floors)	10/10	9/10	7/10	Controllability of building systems (temperature, air, lighting)	10/10	8/10	10/10
Stability	10/10	9/10	7/10	Duration of usability/operation of building services and amenities	9/10	10/10	8/10
Maintainability, condition of components, finishes + fixtures	10/10	9/10	10/10	Accessibility (users incl. disabled) service/maintenance personnel	identical		
Durability	9/10	10/10	8/10	Access control and security (staff, personnel, public)	identical		
Reliability	9/10	8/10	7/10	Fire safety	8/10	10/10	8/10
Thermal protection of envelope / Heat loss and solar gain	10/10	8/10	7/10	Precautions for safety in use (slipping, tripping)	identical		
Sum	9,6/10	8,83/10	7,66/10	Provisions for natural catastrophes	10/10	9/10	8/10
3. Economic Performance				Identity	10/10	7/10	8/10
Investment costs	9/10	8/10	10/10	Integration of building within site and surroundings	7/10	10/10	9/10
Design & Planning costs	7/10	8/10	10/10	Involvement, participation and identification	10/10	7/10	8/10
Building and Construction costs	9/10	8/10	10/10	Aesthetics, spaciousness, image, appearance	10/10	8/10	8/10
Operation and Maintenance costs	identical			Sum	9,4/10	8,5/10	8,6/10
Demolition and disposal costs	9/10	7/10	9/10	6. Process Performance			
Value	10/10	9/10	7/10	Effectiveness and efficiency of design, planning and construction process	10/10	8/10	8/10
Income stream	identical			Management of building service	identical		
Return on investment	10/10	8/10	9/10	Monitoring of technical systems / installations	10/10	8/10	10/10
Sum	9/10	8/10	9,16/10	Availability of data/information for building servicing	9/10	9/10	10/10
4. Environmental Performance				Failure response and efficiency of building servicing	9/10	10/10	9/10
Energy performance class (Energy rating)	10/10	8/10	9/10	Waste management	10/10	8/10	9/10
Resource consumption (power, water, fuel, materials)	identical			Sum	9,6/10	8,6/10	9,2/10
Impacts on environment (emissions, effluents, hazardous waste)	identical			Total Sum	9,5/10	8,38/10	8,79/10
Land use intensity	10/10	9/10	9/10				
Biodiversity	9/10	8/10	10/10				
Reuse-/ recycle-/ deconstruct-ability	10/10	8/10	10/10				
Availability of raw materials Energy intensity for production and construction	9/10	9/10	10/10				
Renewable energy	10/10	6/10	8/10				
Sum	9,6/10	8/10	9,33/10				

1. Functional Performance

- Space clarity

The free-form external shell permits the creation of transparent, well-organised functional and spatial structure.

In case of a pitched roof, the ridge is always situated in the centre of the volume, without making reference to the inner space structure. In the FFB version, the highest point of the building is farther from the living room than in the case of volumes with vertical façades, so spaces for daytime and nighttime activities (living room – dining room – kitchen and bedrooms – bathrooms, respectively) are more easily differentiated. Moreover, we could give these space groups a convex character as opposed to the more neutral, rectangular spaces. It is important to note that architectural elements providing transition between indoors and outdoors can easily be constructed with the shell as well – without the application of the insulation – vide: formation of pent over the entrance to the living room.

The curved external walls make it easier to get around in the building, see the connections of the entryway – living – dining – kitchen – passage on the ground floor. In contrast to usual 90-degree turns, in our version angles are more obtuse.

- Service life

Thanks to the lightweight structure, devices (such as lines and cables) are more accessible for maintenance or modifications; interior claddings can be repaired more easily than in the case of clay brick walls, where plaster is used for finishing.

- Flexibility / Adaptability / Variability

Our construction system is conveniently applicable for interior or exterior conversions and enlargements of existing buildings. Its advantages, from the architectural point of view, is the **freedom of forming space and volume**; from the structural point of view the relatively small additional loads on the foundation and the practicability of structural connections. In case of a detached house, the relation between structure and space forming is mostly a question of interior design – in this case it is especially advantageous that the outer shell does not have interior elements (e. g. columns or beams).

2. Technical Performance

- Stability

The structural report confirms that our structure has a high load-bearing capacity. In comparison with a brick wall strengthened with small reinforced concrete columns of the same load-bearing capacity, the behaviour of our structure, for example in the case of an earthquake, is more favourable from several points of view, such as the structure's resilience, its self weight and its capacity to transmit vibrations to the foundation slab.

- Durability

Even though OSB comes with a warranty of at least 30 years against delamination, and the structure is insulated with plastic foils (so as to minimise damages and size changes caused by humidity and differences in temperature), the durability of the structure is not comparable with that of brick or reinforced concrete. Even so, we are convinced that our structure can serve about 70 years, which is between the durability of the wood based and the brick based structures.

- Thermal protection of envelope / Heat loss and solar gain: See under 5.2 Energetics



3. Economic Performance

- Investment, Building and Construction costs

It is evident that construction costs – material costs and wages – are lowest in the case of „classic” light-weight structures made of timber beams and columns, while in our case preparations (cutting the panels) are necessary, and the remuneration of assemblage is higher. The costs of our structure are lower, though, than those of a block building system: less material is needed for the foundation and reinforced concrete elements, such as the columns or beams to strengthen the walls, are not necessary.

In our case, since the self weight of the structure is low, less material is needed for the foundation than in the case of a traditional building. A foundation slab should be sufficient even for a two- or three-storey building; costs of construction and insulation are lower than those of spread footings.

While for the construction of a traditional building one has to hire several different professionals, such as masons or carpenters, to mount our structure, relatively low technical knowledge is needed, which allows lower wages.

- Design & Planning costs

Compared to the other mentioned construction systems, the costs of planning and design are higher. This difference adds up to 1-1,5% of the total investment value of the building at most.

- Return on investment

Return on investment in case of owned or rented immovables alike is mostly determined by maintenance costs and re-selling possibilities; in both aspects our system is favourable, as the building is energy efficient and has the added value of uniqueness.

4. Environmental Performance

In the construction phase, out of the three considered construction systems, timber frame buildings have the widest range of possibilities to reduce their „ecological footprint”. Eco-friendly construction materials are mostly developed to be appropriate for this system. In our case, for instance, cellulose insulation cannot be – as yet – replaced by natural insulation materials (such as wool or straw), because of the irregular form of the cells to be filled.

During the useful life of the building, though, our system performs even better than timber frame buildings.

Item detailed in chapter 5.4.

5. Social Performance

One of the particularities of our system is that the clients can easily **identify with the building**, given the close and direct working relationship with the architect, which is much needed during the design phase. Likewise, future inhabitants can participate in the mounting of the structure, given that this does not require much technical training. This way the inhabitants can contribute to the construction with their own physical work, identifying themselves with their future home.

The peculiar shape can give personality to the building, which can be an advantage as it helps clients to relate to their house, but this peculiarity is not necessarily favourable for conformity or isolation.

6. Process Performance

The 3D model made during the design phase permits better **control of construction** than the traditional documentation based on projections. It also helps the client to see more of the designed building during planning than if using only 2D projections – floor plans, sections and elevations.

In a shorter term (20-30 years) lightweight buildings – made of wood – are definitely favourable in terms of maintenance or modification; in longer terms (about 50 years), however, modifications can damage the building materials. In the deconstruction process, constructions of concrete and solid or hollow bricks are clearly at disadvantage.

Evaluation criteria are based on:

„A comparison of international classifications for performance requirements and building performance categories used in evaluation methods”

Authors:

Thomas Lützkendorf and Thorsten Speer, Economics and Business Engineering, University Karlsruhe

Françoise Szigeti and Gerald Davis, International Center for Facilities

Pieter C. le Roux and Akikazu Kato, Dept. of Architecture, Toyohashi University of Technology

Kazuhisa Tsunekawa, Dept. of Architecture, University of Nagoya

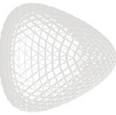
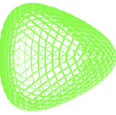
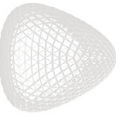
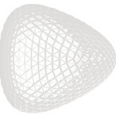
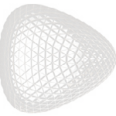
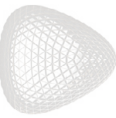

7.1 PERSONAL PRESENTATION

We are forming a team of design experts and constructors, who developed and tested the presented construction method, some of us members of the Hungarian Association of Passive House Builders.

The application of the construction method was analysed from the building energy efficiency (PHPP software) and structural point of views (AXIS), and also by realisation experience (built mock-up), presented in the attached reports.

Furthermore, if our work obtained Your interest, we are disposed to present personally the research material and the marketing and technical development potentials.

From mechanical point of view, we are preparing our houses to be accredited Passive Houses by the Passive House Institute from Darmstadt.

7.2 CONSULTANT DESIGNERS

3D:

Rajnai Csaba
rajnai.csaba@gmail.com

Nagy Gábor
Nagygg@gmail.com

Civil engineers:

Fasching Ferenc Ferdinánd
1097 Budapest, Tóth Kálmán u. 33/C
www.3f-mernokiroda.hu

Árva Péter
1094 Budapest, Viola utca 48
mrd.arva.peter@gmail.com

Mechanical engineer:

Gömöri Csaba
Temesvári Kft. Gömöri Csaba
1119. Budapest, Fehérvári út 83/A
www.temesvariterv.hu

PHPP Calculation:

Benécs József
Passzívház Kft.
2100 Gödöllő Blaháné utca 50.
www.passzivhaz.info.hu

Passive House auditor:

Enikő Sariri-Baffia
Energie Planer Team
Ringstr. 26 D-64342 Seeheim-Jugenheim
www.passivhaus-info.eu

Website, trailer:

Hámori Máté
ZOA Építészeti és Művészeti Szolgáltató Kft.
1053 Budapest Király Pál utca 10.
www.zoa.hu

Booklet assistant:

Meloni Nicola
Hungary, Budapest Beszterce utca 21.
e-mail: nmnicolameloni@gmail.com

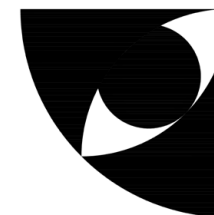
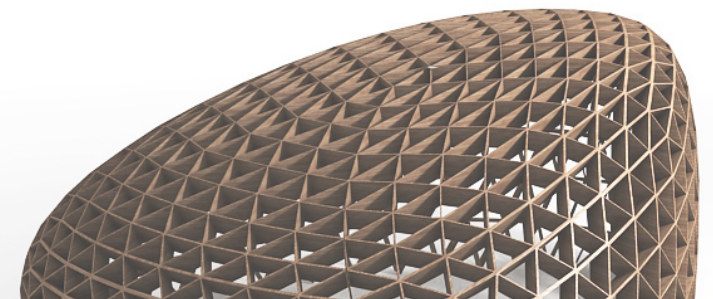

3AR MŰTEREM KFT.
1051 Budapest Arany János utca 7.
www.freeformbuildings.com
PORTIK ADORJÁN
info@freeformbuildings.com
tel.:0036 703 160 749

