

kezelt fa felület, pad



vályog



sövényfal

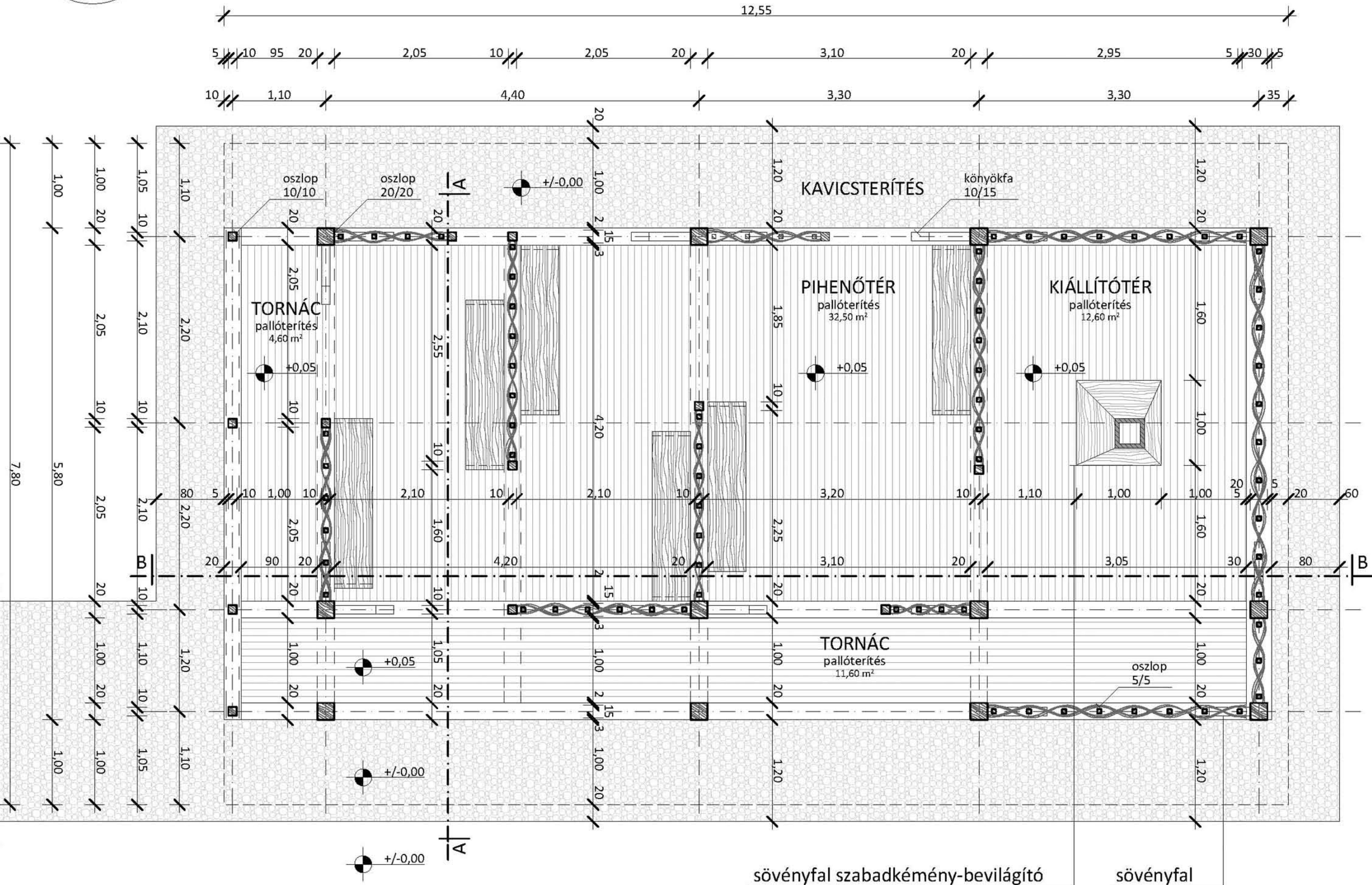

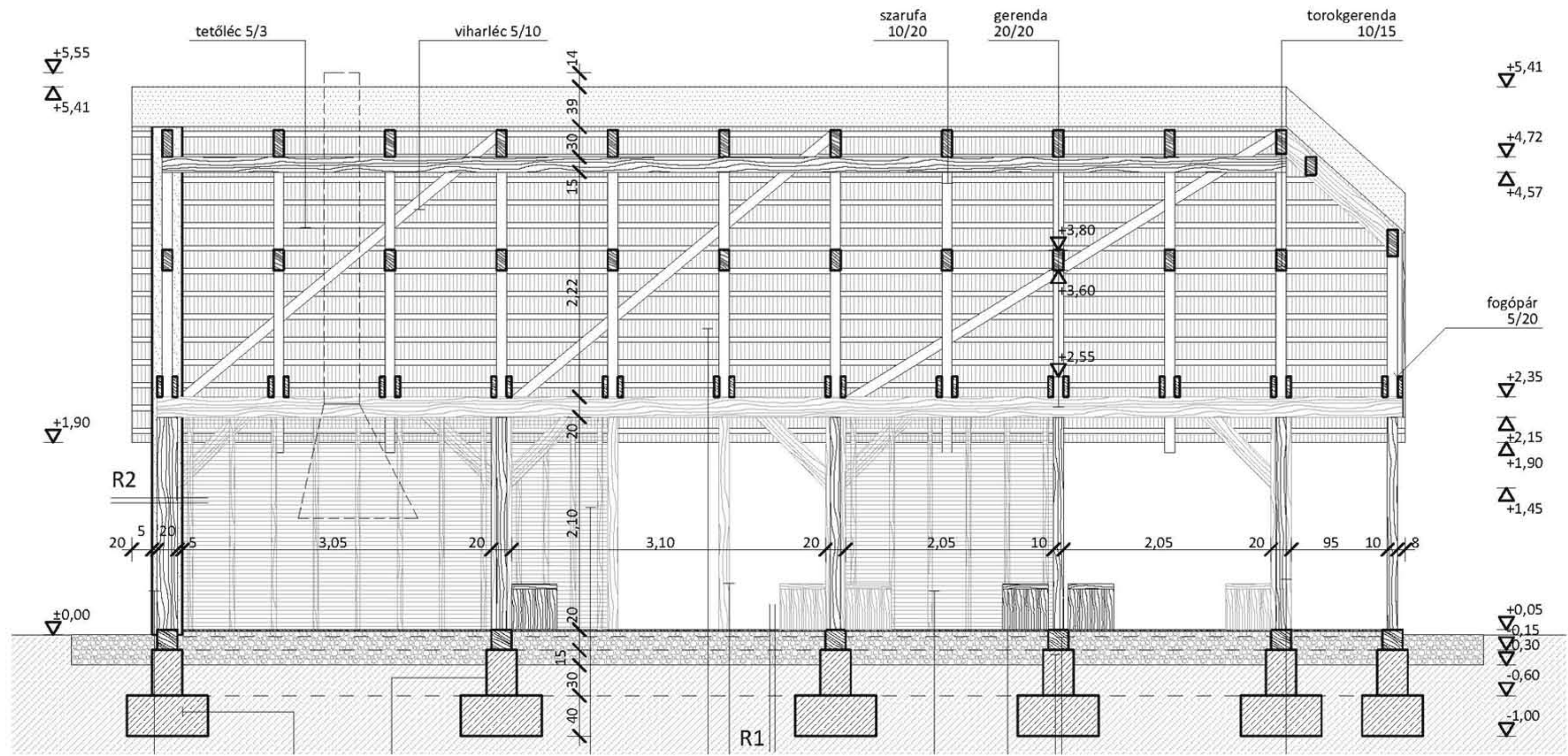
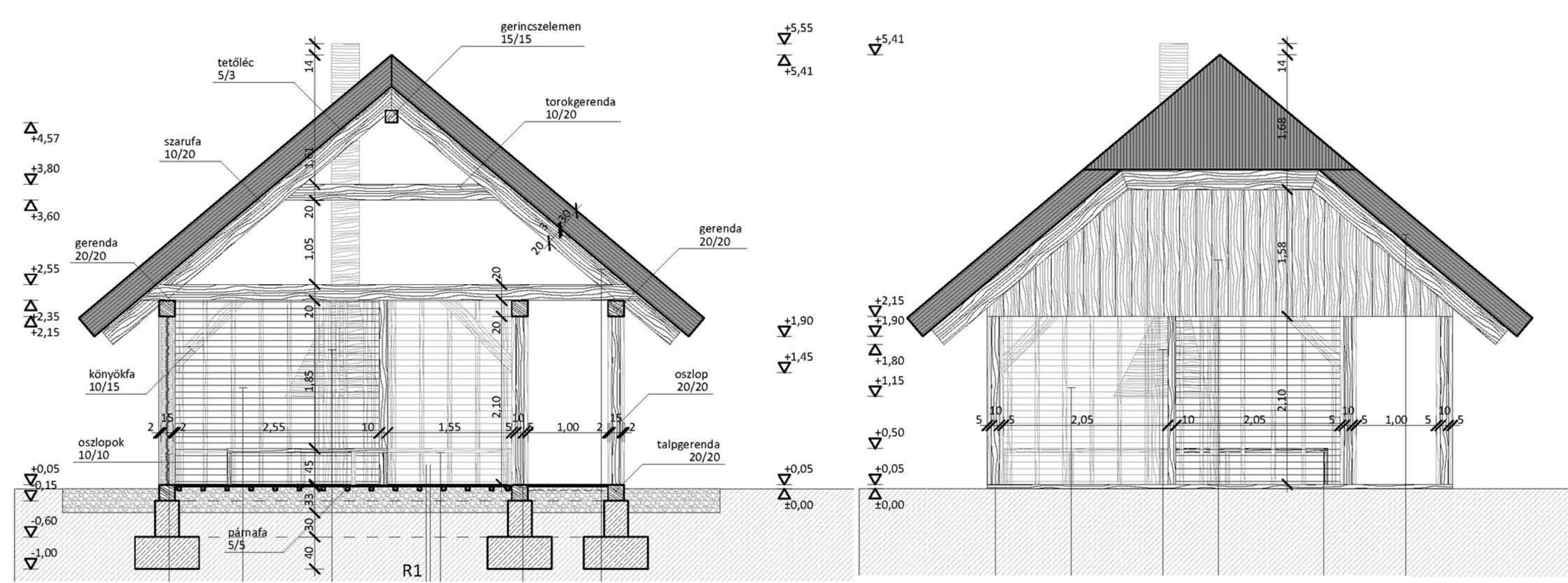

▽+4,72

▽+4,42

▽+4,17

▽+3,94

▽+2,53

▽+2,44

▽+0,35

▽+0,32

▽+0,07

▽+0,00

▽-0,20

▽-0,50

▽-1,50

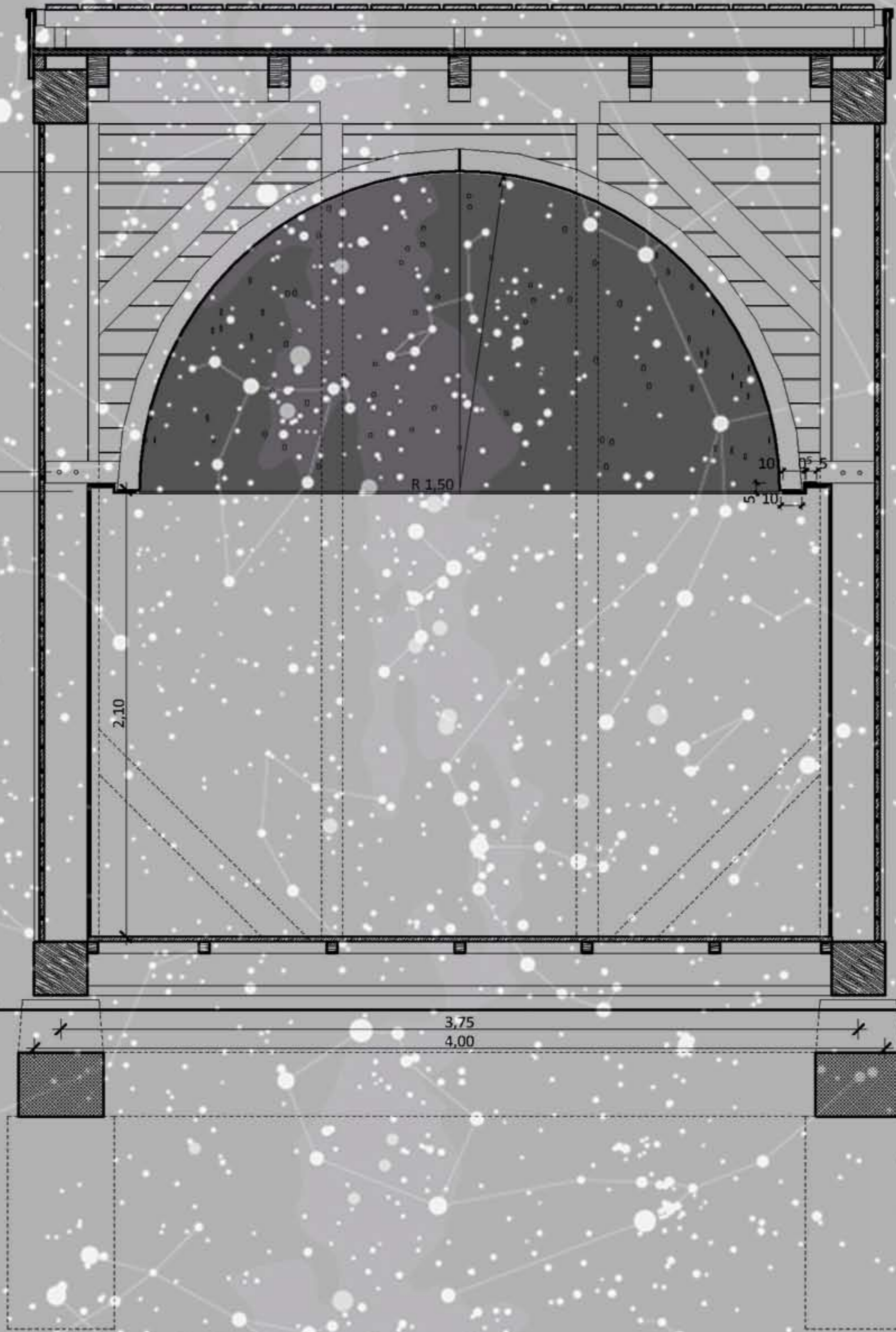

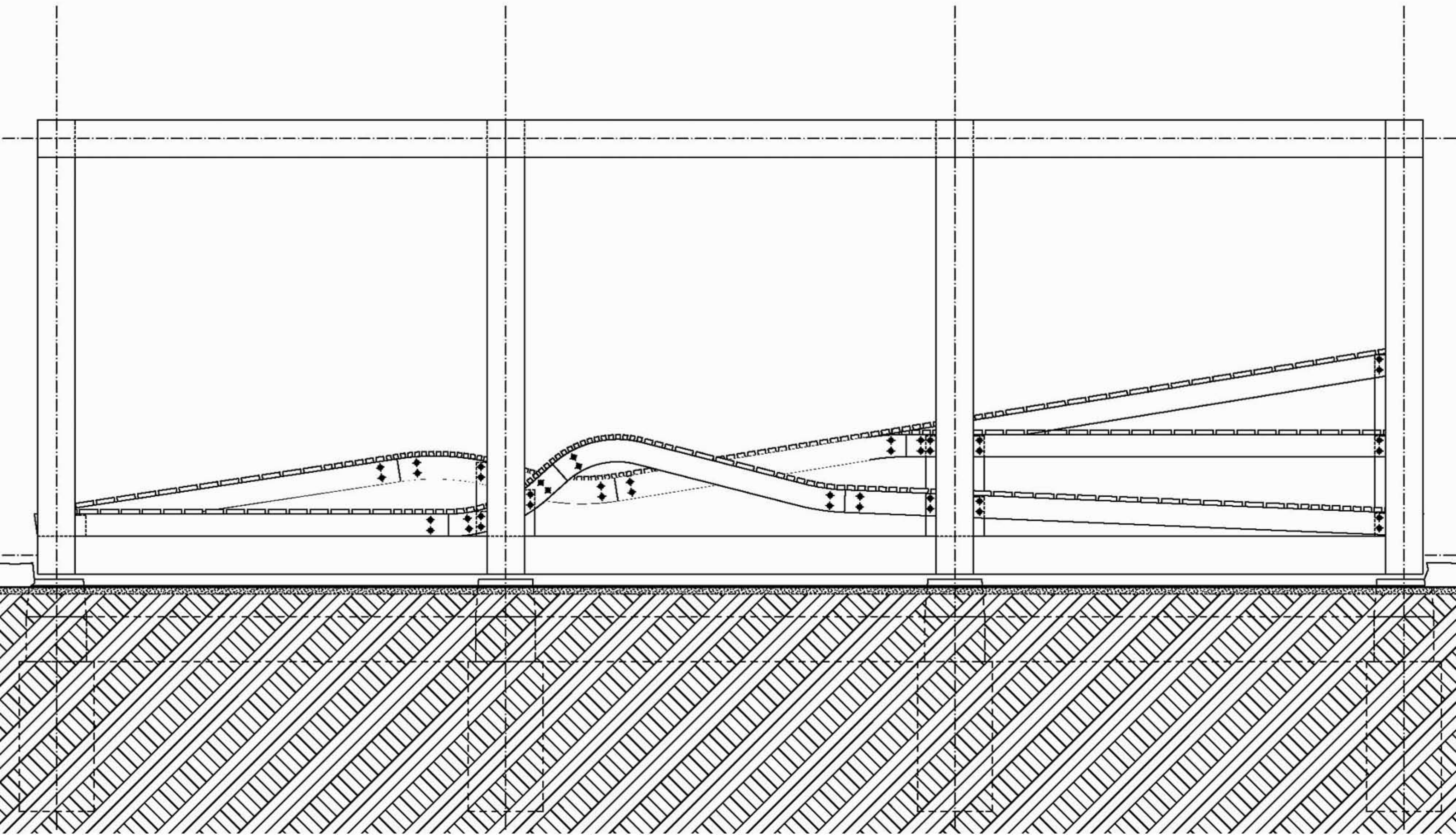

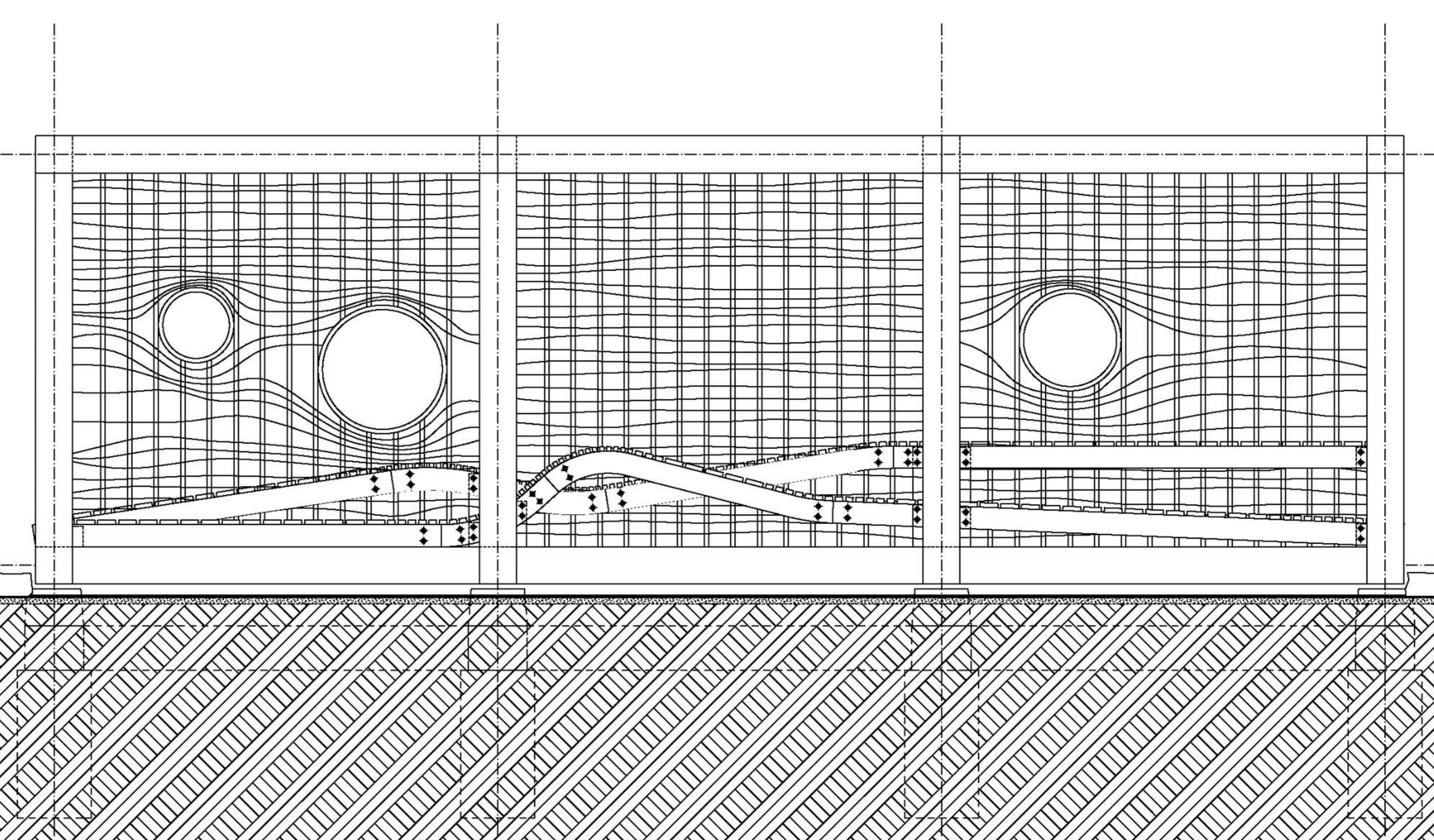

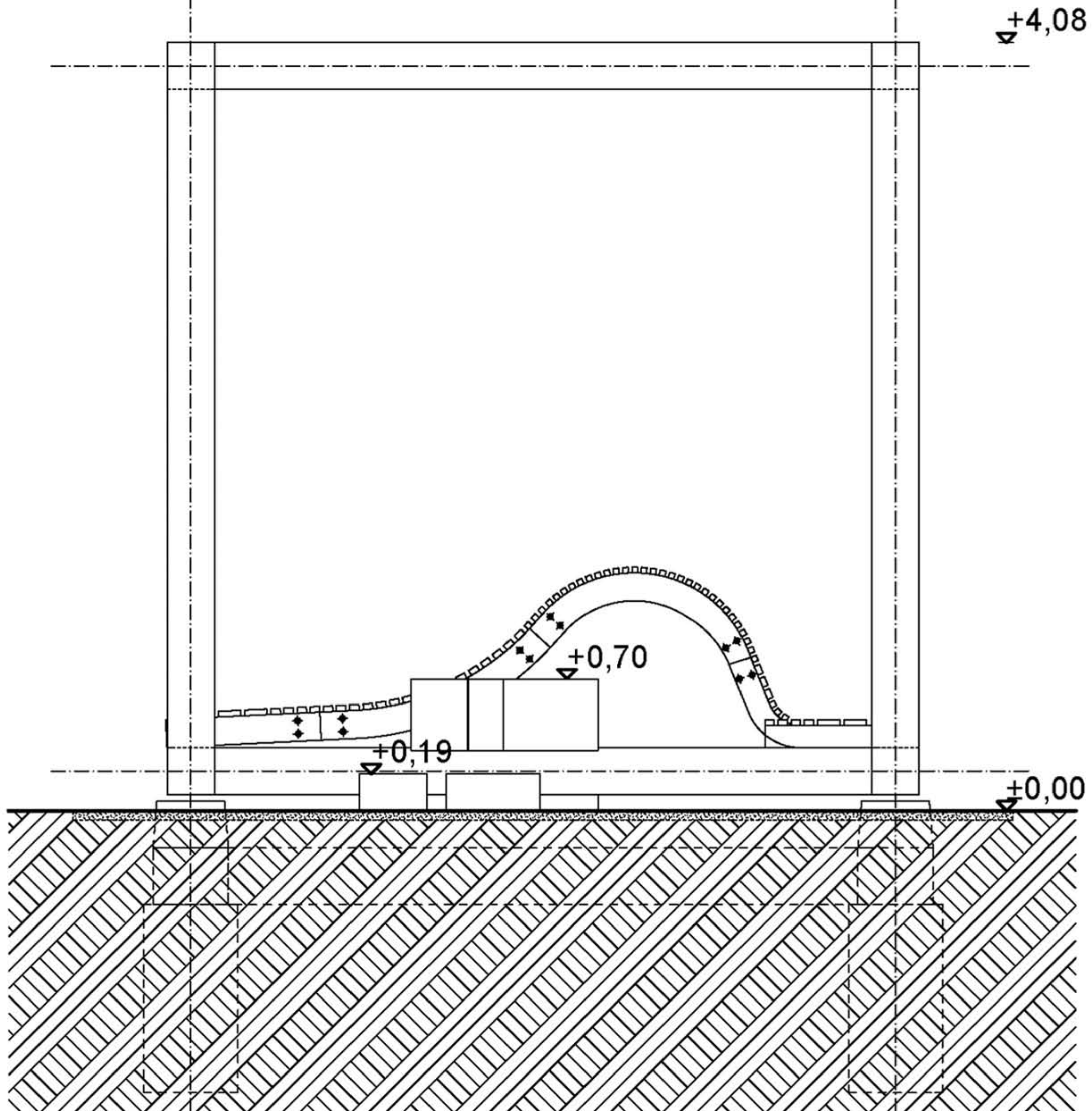

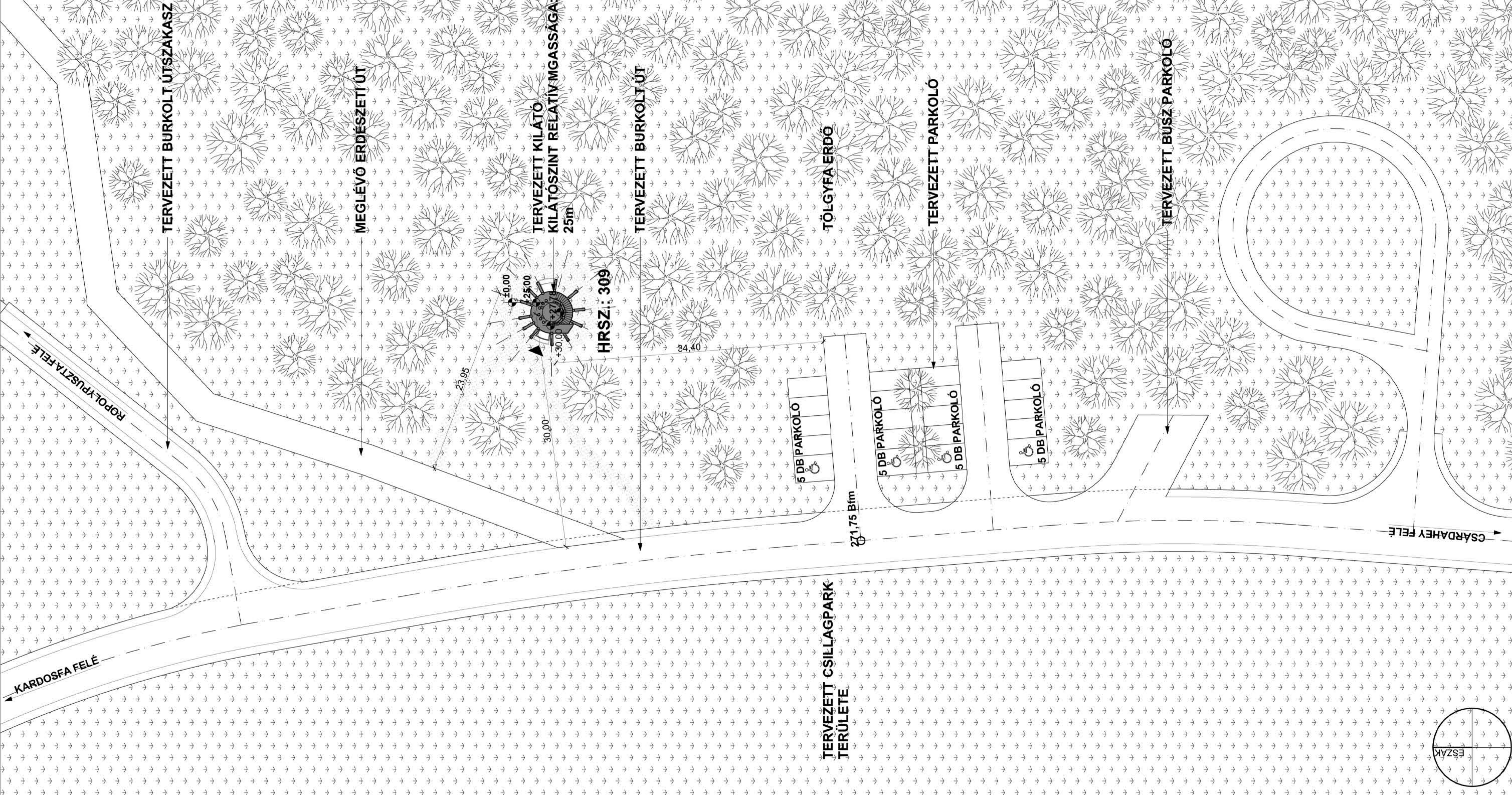

ROPOLYPUSTATA FELE

TERVEZETT BURKOLT ÚTSZAKASZ

MEGLÉVŐ ERDÉSZETI ÚT

TERVEZETT KILÁTÓ
KILÁTÓSZINT RELATÍV MAGSSÁGA:
25m

HRSZ: 309

TERVEZETT BURKOLT ÚT

5 DB PARKOLÓ

5 DB PARKOLÓ

5 DB PARKOLÓ

5 DB PARKOLÓ

TERVEZETT BUSZ PARKOLÓ

TERVEZETT CSILLAGPARK
TERÜLETE

271,75 Bfm

TÖLGYFA ERDŐ

TERVEZETT PARKOLÓ

CSARDAHEY FELE

ÉSZAK

1.szint

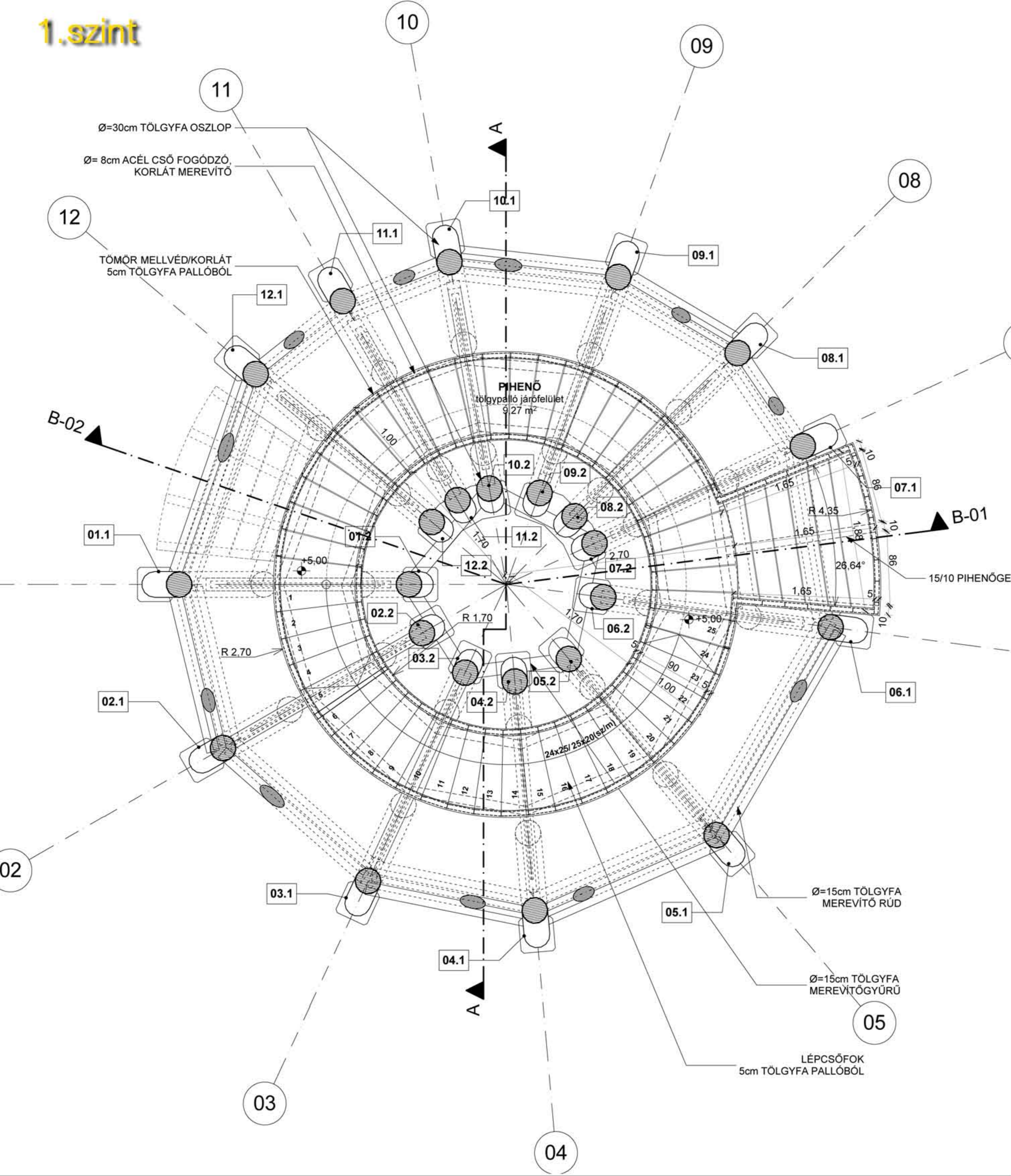

5.szint

